

Nether Langwith

Design Guide and Codes

March 2023

Quality information

Prepared by Checked by Approved by

John-Michael Nick Beedie Lee Wood
Chidwick and Tom
Royles

Mapping licenses

OS Terrain 5 - © Crown copyright and database rights 2022 Ordnance Survey 805286_1032703

OS MasterMap Topography Layer - © Crown copyright and database rights 2022 Ordnance Survey 794815_1020500

Aerial photography - Map Data ©2023 Google

Conservation Area Plans - Copyright Bassetlaw Council

Flood Map for Planning - © Crown copyright and database rights 2021 OS 100024198

Revision History

Issue no.	Issue date	Purpose	Issued by	Comments received	Comments / approved by
1 - Draft sections 1-2	30 November 2022	For Review	Tom Royles, Senior Urban Designer	14 November 2022	Lee Wood Regional Director Janet Smith, Gary Kirk, Debbie Ball NP Advisory Committee
2 - Draft Sections 1-5	20 January 2023	For Review	Tom Royles, Senior Urban Designer	11 February 2023	Janet Smith, Gary Kirk, Debbie Ball NP Advisory Committee
3 - Final Report	06 March 2023	Final report	Tom Royles, Senior Urban Designer	02 March 2023	Lee Wood Regional Director

This document has been prepared by AECOM Limited ("AECOM") in accordance with its contract with Locality (the "Client") and in accordance with generally accepted consultancy principles, the budget for fees and the terms of reference agreed between AECOM and the Client. Any information provided by third parties and referred to herein has not been checked or verified by AECOM, unless otherwise expressly stated in the document. AECOM shall have no liability to any third party that makes use of or relies upon this document.

Contents

1	1. Introduction	5	4	4. Design guidance & codes	55
	1.1 Background	5		4.1 Introduction	55
	1.2 Aims and Objectives	6		4.2 Code topic areas	56
	1.3 Area of study	6		4.3 Character and heritage	57
	1.4 Who will use this document?	8		4.4 Housing, design, and quality	64
	1.5 Planning policy and guidance	8		4.5 Sustainability and energy	70
	1.6 Consultation & engagement	12		4.6 Green and Blue Infrastructure	72
2	2. Neighbourhood Area Context Analysis	15			
	2.1 Location and Context	16			
	2.2 Designations and Allocations	18			
	2.3 Settlement Pattern	20			
	2.4 Heritage and Conservation	22			
	2.5 Landscape	26			
	2.6 Topography and Flood Risk	28			
	2.7 Movement Hierarchy	30			
	2.8 Built form and Density	34			
3	3. Character study and area guidelines	39			
	3.1 Villagescape and landscape identity	39			
	3.2 Character areas	40			
	3.3 Conservation Area: Focus Area	42			
	3.4 Fairfield Close	46			
	3.5 Portland Road	48			
	3.6 Welfitt Grove	50			
	3.7 Character of adjacent neighbourhoods	52			



Introduction

01

1. Introduction

The aim of the Neighbourhood Plan Design Guide and Code is to empower the local community to influence the design and character of the local area and to deliver suitable, sustainable development that meets the needs of local people.

1.1 Background

The Nether Langwith Neighbourhood Plan (NP) advisory committee is producing a Neighbourhood Plan to guide and shape development within the area.

To underpin the NP, this design guidance and design codes document aims to influence the character and design quality of new development across the Neighbourhood Area which will be applied to speculative and infill development and extensions, as well as site allocations, whether these are in the Local Plan or Neighbourhood Plan.

The emerging Local Plan sets out a housing requirement of 11 homes for Nether Langwith – at present it is believed this has been met through a site which has hybrid permission for 38 homes as approved in July 2019 (ref: 16/01216/FUL).

The NP Advisory Committee will consider the allocation of additional sites in a future review of the Neighbourhood Plan should these dwellings not come forward; any allocated sites will need to be appraised and an assessment carried out against clearly identified criteria.

The NP Advisory Committee are keen for the design guidance and codes to define the character and quality of buildings in the Neighbourhood Area so that all new development is more unified and the overall impact of the built environment is improved.

Within this report, design guidance will be provided as per the identified character areas set out in chapter 03 of this report, and will be specific to those areas. The design codes set out in chapter 04 will cover the entire Neighbourhood Area, covering all types of development including any allocated sites to come forward in the future.



1.2 Aims and Objectives

- To positively influence the character and design of new development within the Neighbourhood Area.
- To promote appropriate high-quality, context-driven development within the Neighbourhood Area.
- To identify the character and historic significance of the main settlement within the Neighbourhood Area.
- To understand the impact of any designations as a constraint to development within the Neighbourhood Area including the Conservation Area.
- Analysis of the wider landscape context of the Neighbourhood Area.
- Analysis of development constraints in relation to the Conservation Area and Flood Risk.
- Setting out design codes for future development proposals to adhere to.

1.3 Area of study

Nether Langwith is a village and civil parish in the Bassetlaw district of Nottinghamshire. It is a small community of between 200-250 houses. It is located 9 miles east of Chesterfield, 8 miles southwest of Worksop and 7 miles north of Mansfield. It is 527 hectares in size and lies on the banks of the River Poulter. Directly adjoining the village to the west is Langwith, which is in the district of Bolsover, Derbyshire. The 2021 census states that the population of Nether Langwith is 480.

The village is designated as a Rural Service Centre in the Local Plan (and in the emerging Local Plan) and incorporates several listed buildings and a Conservation Area. The River Poulter which runs west to east, bisects the village. The area around the river and Queens Walk is within Flood Zone 3 (high flood risk).

Much of the development in the parish has been piecemeal and there is no distinctive style, although there are some older buildings with a distinctive character.



Neighbourhood Area

LANGWITH

POULTER COUNTRY
PARK

NETHER
LANGWITH

SHIREBROOK

Figure 01: Neighbourhood Plan Area

0 1km



1.4 Who will use this document?

This document will provide a valuable tool in securing context driven, high-quality development in Nether Langwith. It will be used in different ways by different people in the planning and development process, as summarised in the table below.

Developed through a process of co-design and engagement, the document provides an important contextual analysis of the area and sets out expectations of design quality.

This document alone will not automatically secure optimum design outcomes but will help to prevent poor quality development.

1.5 Planning policy and guidance

This section outlines the national and local planning policy and guidance documents that have influenced this design guidance and codes.

1.5.1 National Planning Policy & Guidance

This chapter provides an overview of the relevant policies within the National Planning Policy Framework and highlights recent government initiatives such as the National Design Guide, National Model Design Code, and Homes England adoption of Building for a Healthy Life (formerly Building for Life 12).

Potential users	How they will use the design guidelines
Applicants, developers, & landowners	As a guide to assist applicants, developers and landowners when developing planning proposals in Nether Langwith, ensuring engagement with the community and the Local Planning Authority and ensuring new development is contextually responsive.
Local planning authority	As a reference point, embedded in policy, against which to assess planning applications. The Design Guidelines should be discussed with applicants during any pre-application discussions.
Parish council or Neighbourhood Plan Advisory Committee	As a guide when commenting on planning applications, ensuring that the Design Guidelines are complied with.
Community groups & local residents	As a tool to promote community-backed development and to inform comments on planning applications.
Statutory consultees	As a reference point when commenting on planning applications.

Table 01: User groups and how they will use the guidance

National Planning Policy Framework (July 2021)

The National Planning Policy Framework (NPPF) outlines the Government's overarching economic, environmental, and social planning policies for England. The policies within the NPPF apply to the preparation of Local and Neighbourhood plan areas, and act as a framework against which decisions are made on planning applications.

The parts of the NPPF which are of relevance to this document are:

- Part 1: Achieving Sustainable Development
- Part 5: Delivering a sufficient supply of homes
- Part 8: Promoting Healthy and Safe Communities
- Part 11: Conserving and Enhancing the Natural Environment
- Part 12: Achieving Well-Designed Places
- Part 14: Meeting the challenge of climate change, flooding and coastal change
- Part 16: Conserving and Enhancing the Historic Environment

The NPPF notes that development that is not well designed should be refused, especially where it fails to reflect local design policies and government guidance on design, considering local design guidance and supplementary planning documents such as design codes.

The NPPF makes clear that all local planning authorities should prepare design guides or codes consistent with the principles set out in the National Design Guide (NDG) and National and Model Design Code (NMDC) which reflect local character and design preferences.

The lineage between policy and outcomes begins with the NPPF. Design has a central role to play in resolving the complexity of change. Good design is both a process and an outcome. Good design creates useable, user-friendly, enjoyable, and attractive places and spaces. Good process develops clarity, builds consensus, and creates certainty for authorities, professionals, and communities. Good process is based around the National Model Design Code (NMDC) core stages of Analysis, Vision, and Code.

National Design Guide (2019) & National Model Design Code (2021)

These companion documents set out characteristics of well-designed places. They support the ambitions of the NPPF to utilise the planning and development process in the creation of high-quality places. The National Design Guide (NDG) states that 'specific, detailed and measurable criteria for good design are most appropriately set at the local level'. The guides are expected to be used by local authorities, applicants, and local communities to establish further design codes (such as this) and guides that can deliver this in line with local preferences.

National Design Guide (2019)

The National Design Guide (NDG) sets the 10 characteristics of a well-designed place and demonstrates what good design is in practice.

The 10 characteristics are:

- **Context** – enhances the surroundings.
- **Identity** – attractive and distinctive.
- **Built form** – a coherent pattern of development.
- **Movement** – accessible and easy to move around.
- **Nature** – enhanced and optimised.
- **Public spaces** – safe, social and inclusive.
- **Uses** – mixed and integrated.
- **Homes and buildings** – functional, healthy and sustainable.
- **Resources** – efficient and resilient.
- **Lifespan** – made to last.

National Model Design Code (2021)

The National Model Design Code (NMDC) sets a baseline standard of quality and practice.

The NMDC provides detailed guidance on the production of design codes, guides, and policies to promote successful design. It expands on 10 characteristics of good design set out in the NDG.

Building for a Healthy Life (2020)

Building for a Healthy Life (BHL) is the new name for Building for Life, the government-endorsed industry standard for well-designed homes and neighbourhoods. The new name reflects the key role that the built environment has in promoting wellbeing.

The BHL toolkit sets out principles to help guide discussions on planning applications and to help local planning authorities to assess the quality of proposed schemes, as well as useful prompts and questions for planning applicants to consider during the different stages of the design process.

1.5.2 Local Policy Context

Bassetlaw District Council and Nottinghamshire County Council are the local authorities that Nether Langwith Neighbourhood Area sits within (planning and highways respectively).

The following documents are essential references to local policy and guidance that have informed the design guidelines and codes. Of relevance is the Bassetlaw Core Strategy and Development Management Policies Document (2011), the Emerging Bassetlaw Local Plan (draft August 2021) and Successful Places Supplementary Planning Document (SPD) (2013).

A comprehensive list of relevant policies is available in the appendix.

Bassetlaw Core Strategy and Development Management Policies DPD (2011)

The Bassetlaw Core strategy provides the overarching framework for all other documents and sets out the vision for change in Bassetlaw to 2028, along with the place-specific policy approaches to be taken to achieve this vision.

The Core Strategy identifies Nether Langwith as a Rural Service Centre. These rural settlements offer a range of services and facilities, and the access to public transport, that makes them suitable locations for limited rural growth.

Successful Places SPD

This SPD was prepared jointly by Chesterfield Borough, Bolsover District, Northeast Derbyshire District and Bassetlaw District Councils. This residential Design SPD:

- Identifies the standards of design expected by the four local authorities.
- Provides direction on the principles of good design within residential developments; and
- Provides information and guidance on the design process.

This design code aims to add place specific detail and depth to the design principles of the SPD without retreading the same ground.

The Draft Bassetlaw Local Plan (2020 – 2038) August 2021

Bassetlaw District Council submitted the Bassetlaw Local Plan 2020-2038: Publication Version to the Secretary of State on 18 July 2022 for independent examination, in line with the Town and Country Planning (Local Planning) (England) Regulations 2012 (2) - Regulation 22. It is anticipated that the Local Plan will be adopted in the summer of 2023 where it will replace the existing policies set out in the adopted Core Strategy.

Other Supplementary Planning Documents (SPDs)

Bassetlaw District Council have produced several other SPDs which offer additional guidance of a more specialised nature which covers a range of issues, both thematic and site-specific in scope. Bassetlaw’s portfolio of SPDs positively address several local planning matters, complementing several policies in its Core Strategy. Relevant SPDs include:

- Affordable housing SPD
- Residential Parking Standards SPD
- Shopfront and Signage SPD
- Residential Design SPD (Successful Places)

1.6 Consultation & engagement

An inception call between AECOM consultants and a representative of the NP advisory committee was conducted to introduce the consultant team and explore the key aims and objectives the group wish the Design Guide and Codes to identify and respond to.

This was followed by a walk around the Neighbourhood Area which was conducted by AECOM consultants on the 26th of July, 2022, to assess character and key features that inform the sense of place.

The site visit provided valuable perspectives on the current and historic issues, constraints, and opportunities.

Local Planning Policy & Guidance	Relevant Policies and Guidance Notes
Bassetlaw District Core Strategy	Policy CS8 Rural Service Centres Policy DM1 Economic development in the countryside Policy DM3 General development in the countryside Policy DM4 Design and character Policy DM5 Housing mix and density Policy DM8 The historic environment Policy DM9 Green infrastructure, biodiversity and geodiversity, landscape, open space, and sports facilities DM12 Flood risk, sewerage, and drainage Policy DM13 Sustainable transport
Successful Places SPD (2011)	02 Delivering Quality – the Design Process 03 Place Making Principles - Good Urban Design Practice 04 Management and Maintenance – Enduring Quality

Table 02: Local Planning Policy & Guidance

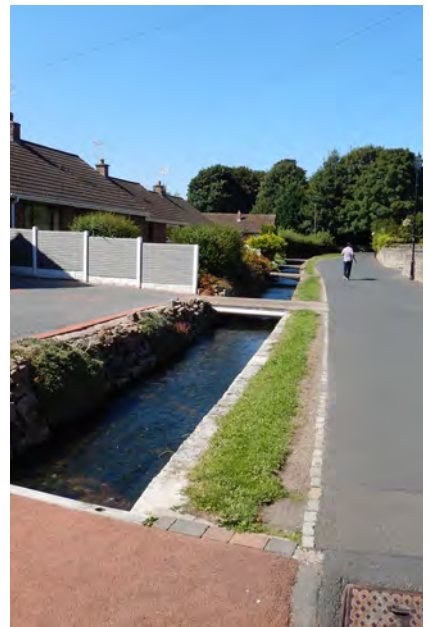

Figure 02: Images of the Neighbourhood Area



Neighbourhood Area
Context Analysis

02

2. Neighbourhood Area Context Analysis

This chapter presents a contextual analysis of the Neighbourhood Area. It will provide an overview of Nether Langwith's historic origins and settlement growth, an analysis of the key topics such as topography and flood risk, movement hierarchy, landscape character, blue and green infrastructure features, and an introduction to built form and density. The outcomes of this analysis have helped to derive the character areas set out within Chapter 3.

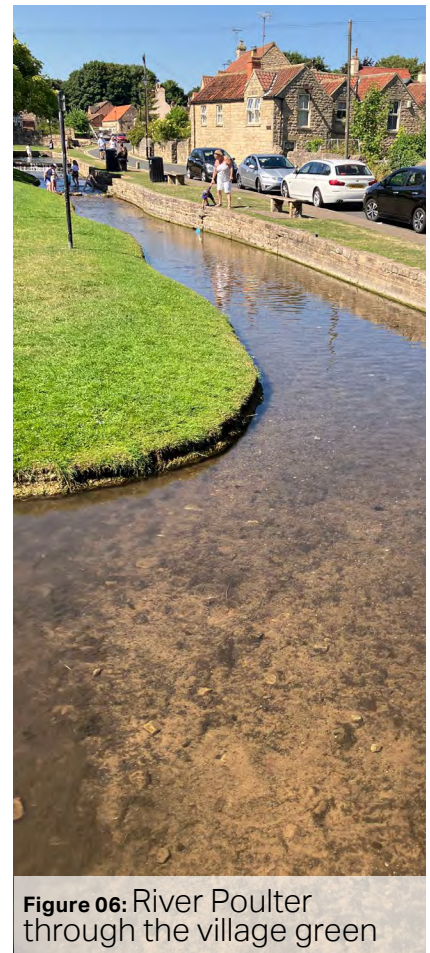

2.1 Location and Context

Nether Langwith is a village and civil parish on the border of Nottinghamshire and Derbyshire, with the village itself falling within the Bassetlaw district of Nottinghamshire. Directly adjoining Nether Langwith to the west are the villages of Langwith, Whaley Thorns and Upper Langwith which each fall within the Bolsover district of Derbyshire. Nether Langwith is located nine miles east of Chesterfield, eight miles southwest of Worksop and seven miles north of Mansfield, each large local centres containing numerous amenities. The village is located on the banks of the River Poulter in a predominantly rural area consisting of agricultural land, ancient woodlands and the Poulter Country Park.

The A632 (known as Main Road as it runs through the village) is the main arterial route connecting the village to Bolsover to the west and Cuckney and the A60 in the east through the centre the village. A railway line runs through Whaley Thorns and Langwith to the west of the village with the nearest train stations located at Langwith-Whaley Thorns (within one mile of Nether Langwith to the northwest) and Shirebrook (within three miles of Nether Langwith to the south).



Figure 08: Residential property on Main Road



Figure 09: Rhubarb Farm at Hardwick Street



Figure 10: War memorial on the Village Green



TO WHALEY
HOLBECK

COCKSHUT LANE

TO HOLBECK

BLUE BARN
FARM

LANGWITH-WHALEY
THORNS TRAIN
STATION

PORTLAND
ROAD

WELFITT
GROVE

LANGWITH
LODGE DRIVE

PASTURE HILL
FARM

TO A60
CUCKNEY
WORKSOP
MANSFIELD

FAIRFIELD
CLOSE

QUEENS
WALK

A632 (MAIN ROAD)

RIVER POULTER

LANGWITH
MILL

TO M1
BOLSOVER
CHESTERFIELD

LIMES
AVENUE

BOON
HILLS
FARM

WOOD LANE

LANGWITH

TOP FARM

TO CHURCH
WARSOP

Figure 11: Context Plan

0





1km

2.2 Designations and Allocations

There are several significant designations within and adjacent to the Neighbourhood Area. These are illustrated on the adjacent plan (figure 12) and they comprise the following:

- The Nether Langwith Conservation Area, which extends from Queens Walk along Main Road to Langwith Mill (discussed in further detail in section 2.4).
- 12 listed buildings and assets (also discussed in further detail in section 2.4).
- Lord Stubbins Wood Site of Special Scientific Interest, located to the south of the Neighbourhood Area (also discussed in section 2.5).
- Several areas of ancient woodland (also discussed in section 2.5).



-  Site of Special Scientific Interest
-  Conservation Area
-  Landscape Designations
-  Listed Assets
-  Planning approval (16/01216/FUL)

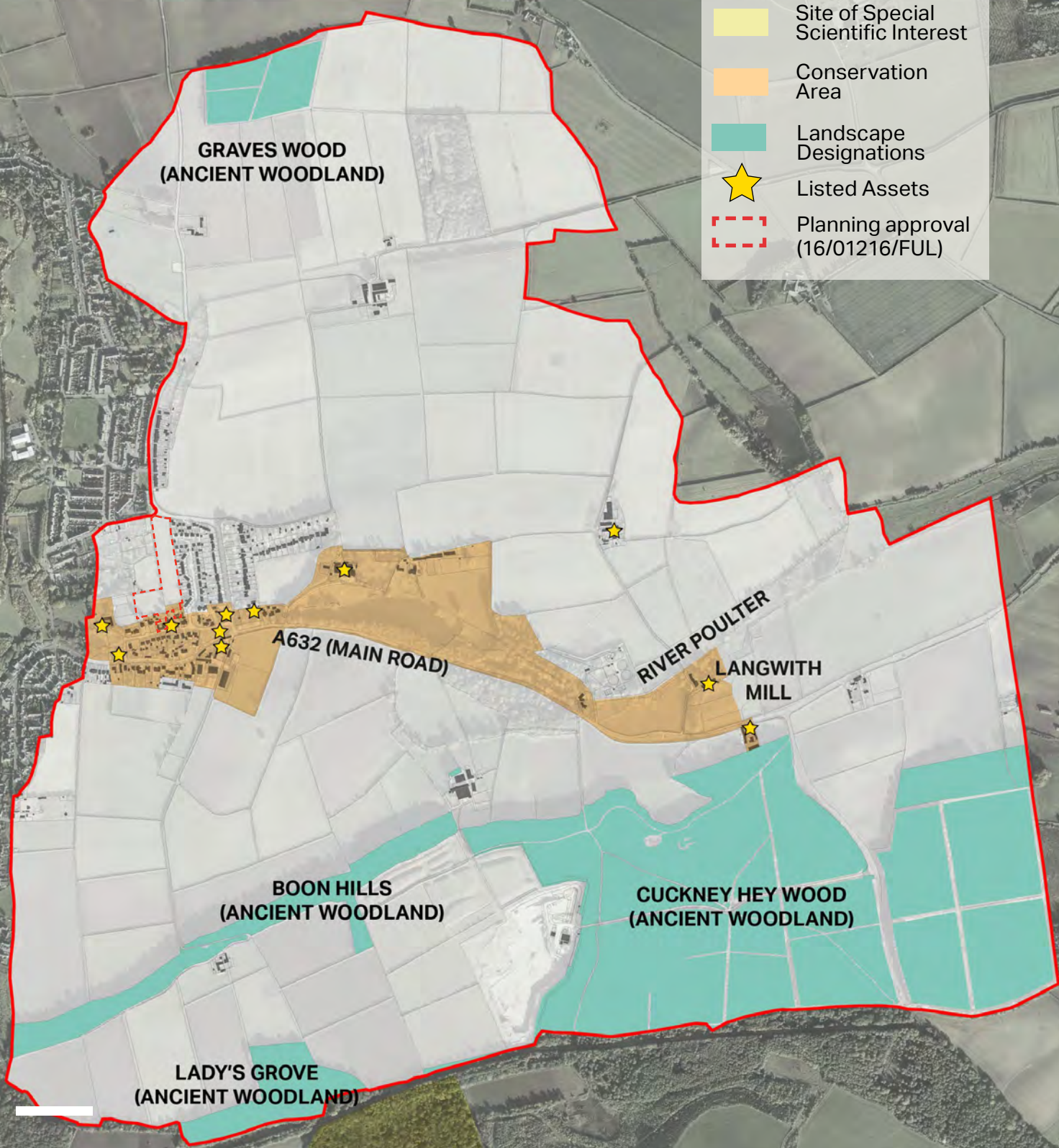

Figure 12: Designations in the Neighbourhood Plan area and the surroundings

2.3 Settlement Pattern

The figure-ground plan of a settlement (see over page) can be likened to its DNA, encapsulating its personality. Both good and bad traits are apparent in the simple display of solid black building areas (the 'figure') set against a white background representing undeveloped land (the 'ground'). When assessing building size, density and relationships between buildings and spaces, this plan type is a great indicator of different characters, or periods of development, throughout the village.

Nether Langwith is situated within a rural setting and is surrounded by agricultural land and ancient woodlands. The wider Neighbourhood Area is predominantly open in character with large expansive fields bounded by mature hedgerow comprising the main landscape feature. The village itself makes up approximately 16ha of the 527ha that makes up the Neighbourhood Area and comprises a small number of streets, extending from the Village Green in the South of the Area to Portland Road heading North.

The buildings on the historic Main Road and Queens Walk represent a variety of ages and styles including 18th century farmstead buildings and detached houses along with 20th century bungalows and semi-detached houses. Queens Walk contains numerous landmark buildings including the Village Hall and the Grade II listed pub, the Jug & Glass Inn.

The houses along Limes Avenue, Fairfield Close and Welfitt Grove at the north of the village are more suburban in nature and consist of 20th century bungalows and semi-detached houses. There are also several 21st century cul-de-sac developments at Limes Acres, the top of Fairfield Close, and Farm Court.

To the east of the village is the Grade II listed Langwith Lodge, a care home which sits on the banks of the river Poulter. Several farmsteads sit isolated from the village to the east.



■ Figure Ground

scale 1:15000

300m

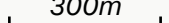

Figure 13: Figure ground plan of the Nether Langwith Neighbourhood Area

2.4 Heritage and Conservation

2.4.1 History

The name 'Langwith' may be derived from Old Norse, meaning 'long ford' and 'Nether' may be Anglo-Saxon, meaning 'lower'. The oldest remaining parts of the village are located around the River Poulter in the Nether Langwith Conservation Area. During the 1800s Nether Langwith mainly consisted of small mills and farmsteads. The local St Luke's church in neighbouring Whaley Thorns was built in 1879. During the late 1800s and early 1900s there was a rapid expansion of Whaley Thorns to the west around Langwith-Whaley Thorns railway station and the Langwith Colliery. There was further residential expansion from the 1920s onwards, ultimately connecting Nether Langwith with the surrounding villages.

2.4.2 Conservation Area and Listed Buildings

A significant portion of Nether Langwith falls within the Nether Langwith Conservation Area which was designated in June 2010 and is one of 29 Conservation Areas in Bassetlaw. The Conservation Area is focused on the historic core of the village around Queens Walk and Main Road, including the village green, an area of open grassland, narrow to the east and broader to the west. A key feature of the Village Green is the Grade II listed Nether Langwith War Memorial dating from the 1920s. In the southwest corner of the Village Green there is a late 19th century sheep wash.

Numerous buildings in the Conservation Area date from the 18th and 19th centuries with a local characteristic style of limestone and red clay roof-tiles. The Conservation Area extends eastwards to include Langwith Lodge and the remains of the historic Langwith Cotton Mill area, an important industrial grouping including a former manager's house and a four-storey mill.

There are nine Grade II listed buildings and sites in Nether Langwith itself and three further Grade II listed buildings separate to the main body of the village to the east. Most notable are Langwith Lodge (an Edwardian manor turned care home), the Jug & Glass Inn (a Georgian pub and popular community hub) and the Nether Langwith War Memorial which acts as a focal point for the Village Green.



Figure 14: The Grade II Listed Stone Cottage



Figure 16: Tourist information board



Figure 15: The Grade II Listed Jug & Glass Inn



Figure 17: Sheep wash sign at the Green



Figure 18: Blacksmiths shop sign at the Green



Figure 19: Langwith Lodge care home



Figure 20: Terraces fronting the Green, Queens Walk

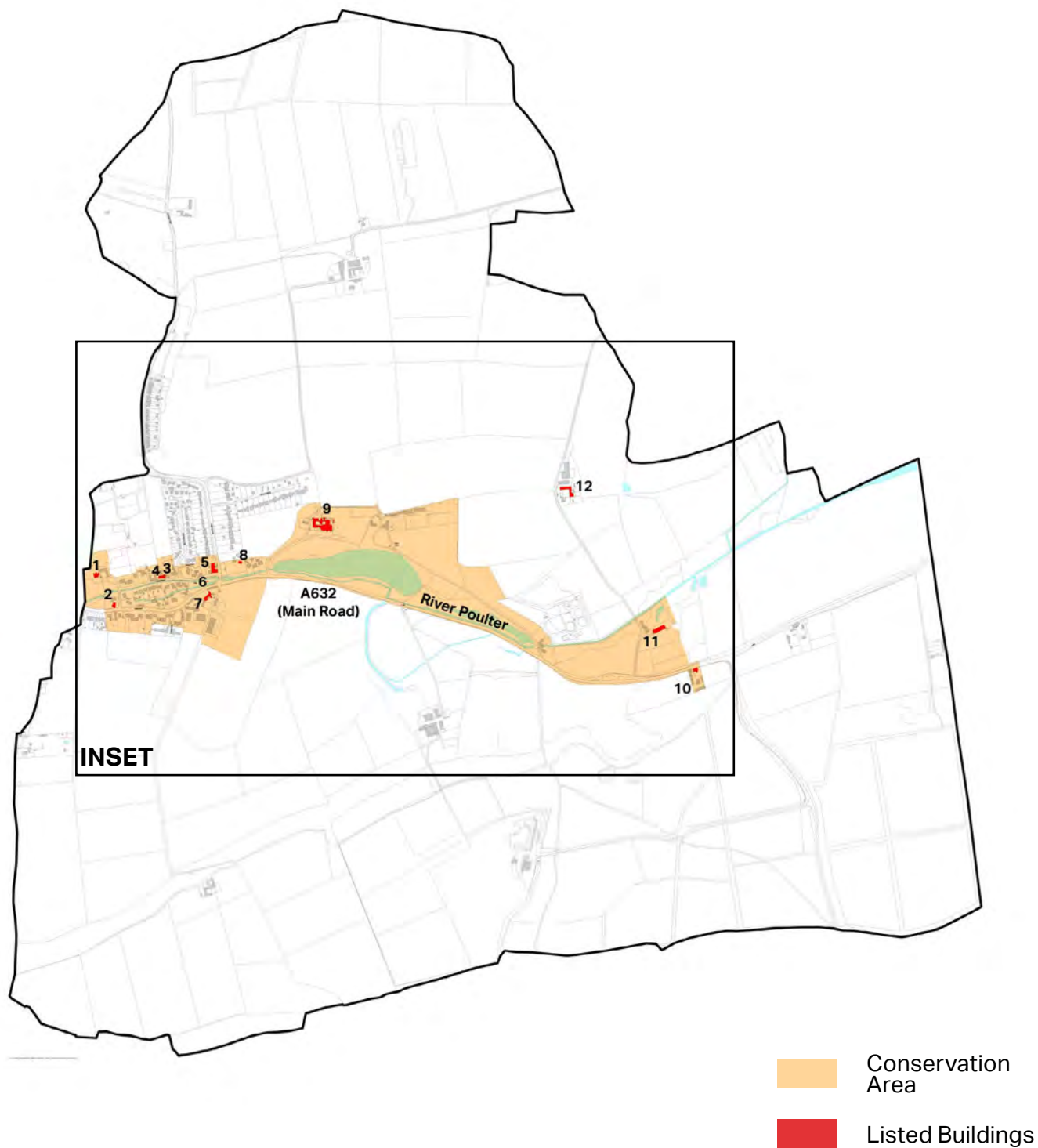

Figure 21: Listed buildings in the Neighbourhood Plan area

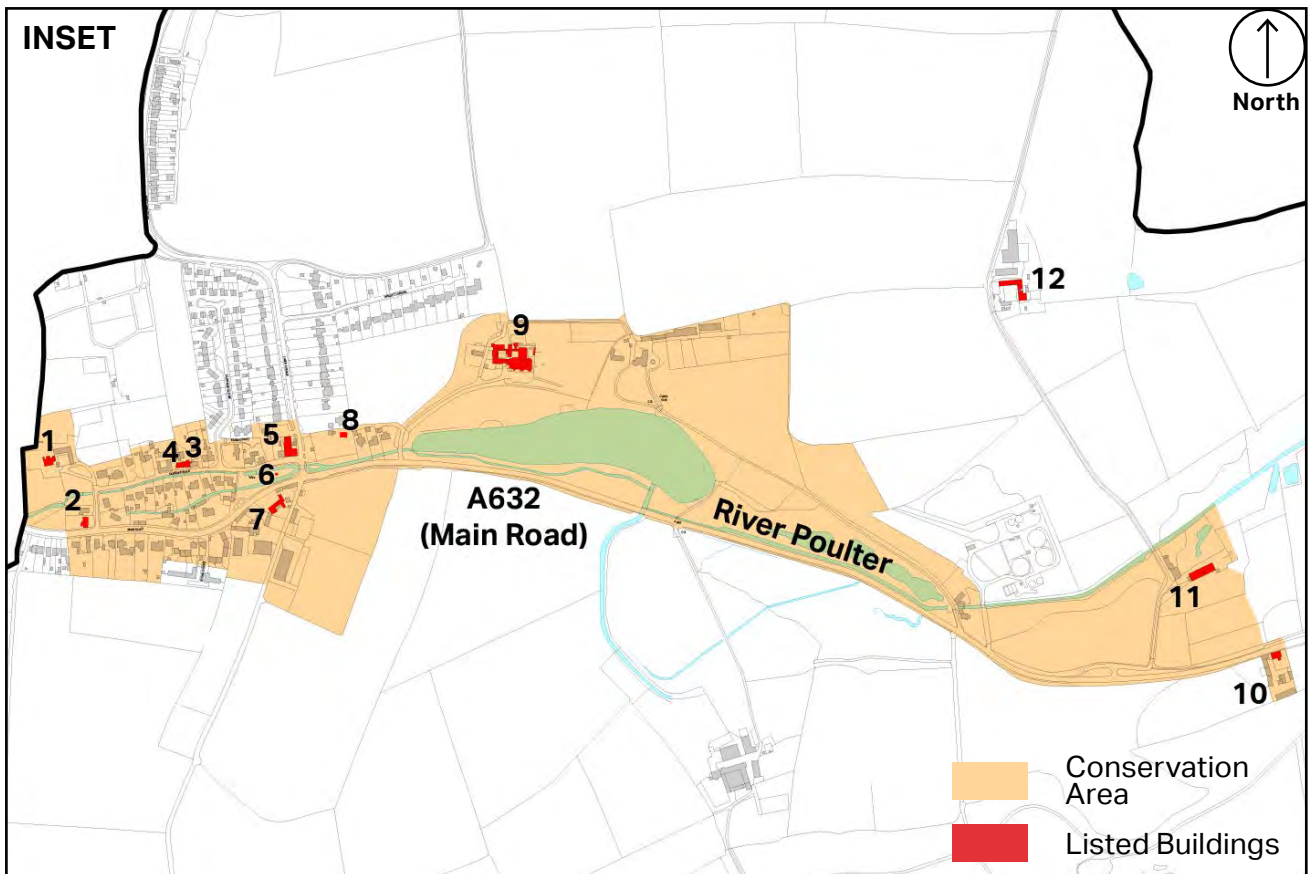

Figure 22: Inset of listed buildings plan

GRADE	HERITAGE ASSET	
Grade II	1	Langwith House
	2	Stone Cottage
	3	Connie Tom
	4	Greenrigs
	5	The Jug and Glass Inn
	6	Nether Langwith War Memorial
	7	Brook House Farmhouse
	8	West Cottage
	9	Langwith Lodge
	10	The Farm Cotton Mill
	11	Cotton Mill
	12	Pasture Hill Farmhouse

Table 03: Listed buildings in the Neighbourhood Plan area

2.5 Landscape

The Neighbourhood Area lies to the east flank of the Pennines and occupies a wide valley of the river Poulter (a tributary of the River Idle and the River Trent) which runs through the village from west to east. The river branches into two streams as it passes through the village. The stream along Queens Walk separates several bungalows from the road which requires them to be accessed by several small bridges. The river then widens to form a large pool overlooked by Langwith Lodge at the east of village. It narrows again as it continues eastward.

The Neighbourhood Area's generally flat (in places, gently undulating) terrain allows for long views across the landscape which is only punctured in places by small copses of woodland and mature hedgerow. Isolated mill buildings, farms and agricultural paraphernalia are a common feature in the landscape. The boundary between the landscape and villagescape is typically defined by the vegetated rear boundaries of terraced and semi-detached dwellings which follow historical field boundaries. The mature hedgerow and trees screen the rear boundaries and mitigate their impact on the wider landscape setting.

There are numerous areas of woodland surrounding the village including Graves Wood and Gorse Covert to the north and Boon Hills Wood and Cuckney Hay Wood to the south. Immediately to the west of the village sits the Poulter Country Park which is a popular green space including several trails, sites of interest and areas of wildlife.

NATIONAL LANDSCAPE CHARACTER AREA ASSESSMENT (2014)



The Neighbourhood Area falls within NCA30, a landscape character area identified in the National Landscape Character Area Assessment (NCA, 2014). This assessment identifies areas that share similar landscape characteristics, and which follow natural lines in the landscape rather than administrative boundaries, making them a good decision making framework for the natural environment.

NCA30: SOUTHERN MAGNESIAN LIMESTONE

Nether Langwith falls within NCA30, a summary of its characteristics are stated below:

- Fertile, intensively farmed arable land with large fields bounded by clipped hawthorn hedges.
- Woodlands combined with open arable land to create a wooded farmland landscape.
- Long views over lowlands to the east and west, and most prominent in the south.
- Large number of country houses and estates with designed gardens, parkland's, and woodlands.
- Unifying influence of creamy white Magnesia Limestone used as a building materials and often combined with concrete pantile roofing.
- Underlying limestone creating a smoothly rolling landform.



-  Woodland
-  Watercourses and ponds
-  Open views

Poulter Country Park
←

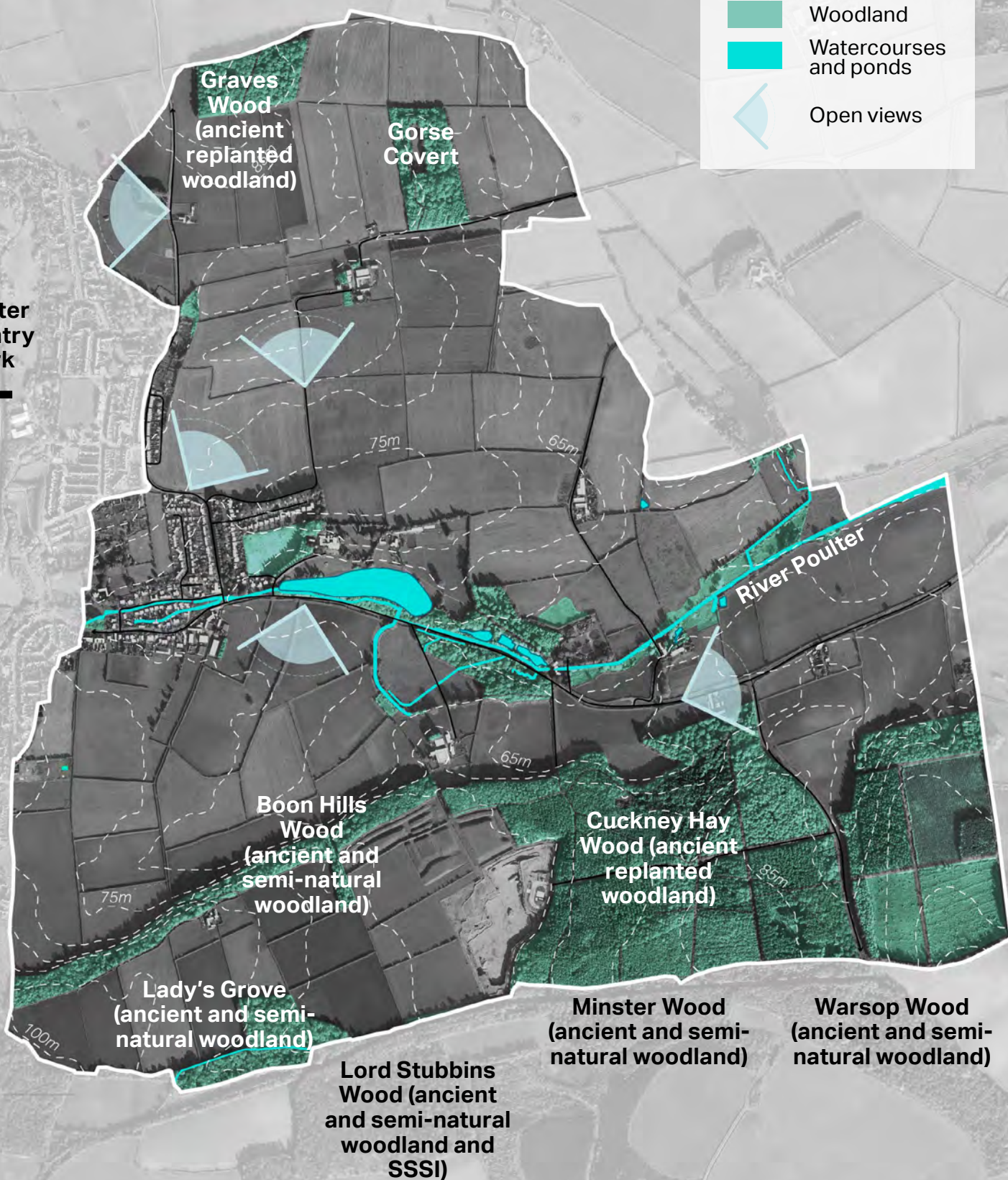

Figure 23: Key landscape features and topography in the Neighbourhood Area

scale 1:15000
300m

2.6 Topography and Flood Risk

Nether Langwith sits within a low-lying valley east of higher land between Bolsover and Scarcliffe Park. The built area of Nether Langwith sits between 70-75m AOD (Above Ordnance Datum). The lowest parts are along the River Poulter. The land immediately surrounding the river is at the highest risk of flooding, in particular along Queens Walk and Main Road at the points where the river branches into two separate streams which pass very close to the local homes.



Figure 24: The River Poulter along Queens Walk



Figure 25: Long views across landscape

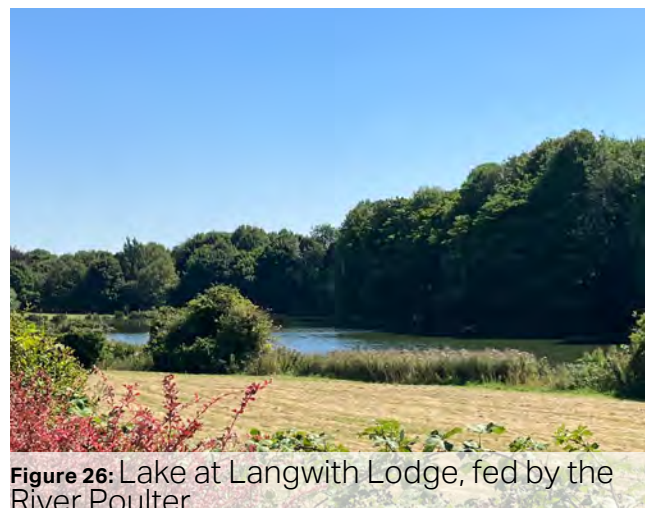

Figure 26: Lake at Langwith Lodge, fed by the River Poulter

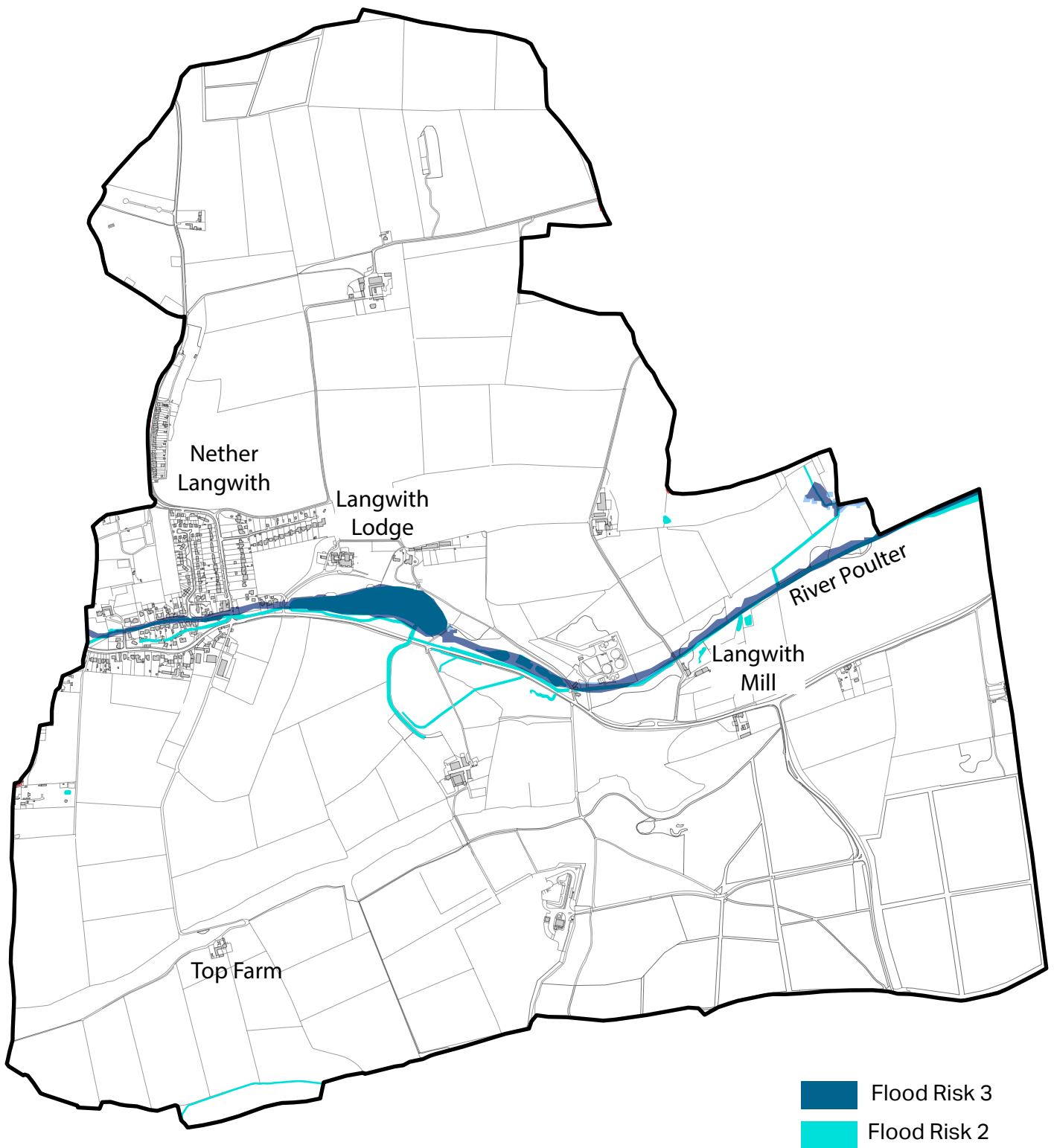

Figure 27: Flood Risk map of Nether Langwith

300m
scale 1:15000

2.7 Movement Hierarchy

Main Road is the main arterial route running from east to west of Nether Langwith and is the main access point for all other streets in the village. Queens Walk has some of the qualities of a main pedestrian route on account of its historical interest and the sites of interest along it including the Village Hall and the Jug & Glass Inn. However, a lack of pavements on Queens Walk makes it challenging for pedestrians to navigate. Other roads in the village are predominantly residential and therefore mainly only used by residents.

2.7.1 Public Transport Infrastructure

A north-south railway line runs through the villages of Whaley Thorns and Langwith to the west with the nearest train stations being Langwith-Whaley Thorns (within one mile of Nether Langwith to the northwest) and Shirebrook (within three miles of Nether Langwith to the south). A two-hourly train service runs from Worksop to Nottingham every day other than Sunday. There are bus services connecting Nether Langwith to Bolsover, Chesterfield, Mansfield, Worksop and Warsop with bus stops situated along Main Road. However, the infrequency of these services means that car usage amongst local residents remains high.

2.7.2 Vehicle Routes

The A632 (known as Main Road as it runs through Nether Langwith) is the main route connecting Bolsover and the M1 to the east and Cuckney and the A60 to the west. Queens Walk links the east and west of the village and, together with Main Road, creates a loop around the historic core of the village. Limes Avenue is a secondary route leading to Portland Road in Langwith and ultimately exiting into the countryside. The residential streets of Fairfield Close and Welfitt Grove are tertiary routes with limited permeability leading to either cul-de-sacs or private driveways/roads.



Figure 28: Route hierarchy and public transports in the Nether Langwith Parish area

2.7.3 Pedestrian and Cycle Connectivity

The main pedestrian streets are Main Road and Queens Walk. Main Road includes a wide pavement however, due to the historic nature of Queens Walk, there are no footpaths: On one side historic walls butt up to the road; on the other, grass verges buffer the road from the river. On one side, the historic walls directly sit against the vehicular road. On the opposite side, grass verges act as a buffer against the stream. The residential streets at Fairfield Close and Limes Avenue are lined by pavements, at times separated from the road by grass verges.

The residential area of Welfitt Grove lacks any pavements despite there being space to accommodate them. Pedestrians are therefore required to walk on the road. Newer cul-de-sacs such as Lime Acres also lack pavements which gives a clear priority to vehicle parking. Numerous public rights of way directly connect the village with the surrounding countryside and ancient woodlands. There are no designated cycle lanes in Nether Langwith despite cyclists regularly passing through the village to access the surrounding Derbyshire countryside. However, National Cycle Route 648 runs to the south of the Neighbourhood Area and connects from Shirebrook Station to National Cycle Route 6 to the east.



Figure 29: Public Rights of Way



Figure 30: Lack of pavement on Queens Walk



Figure 31: Lack of designated cycle lane on Main Road

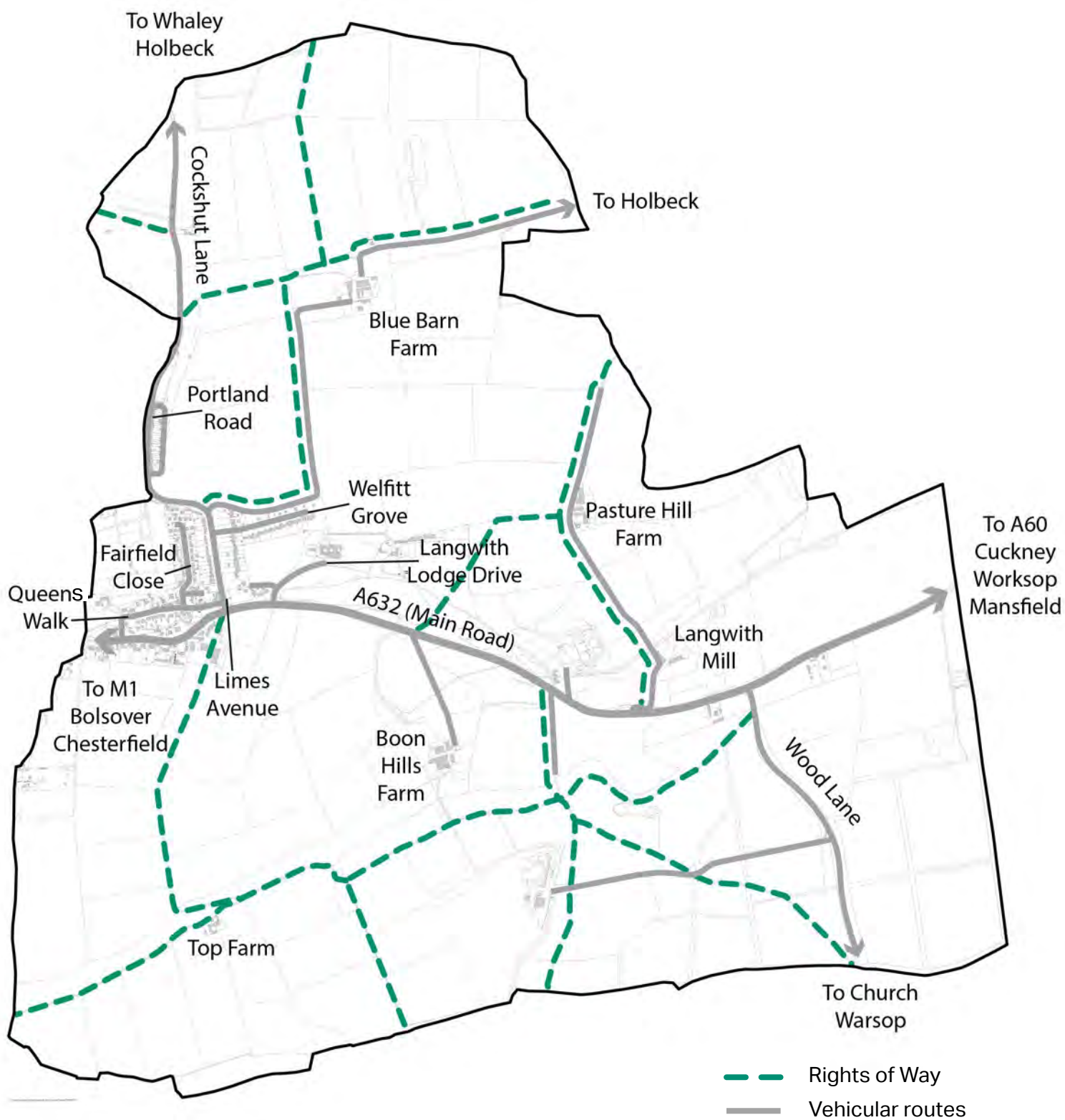

Figure 32: Rights of Way in the Nether Langwith Parish area

2.8 Built form and Density

Nether Langwith is generally low density (predominantly between 15 and 20 dwellings per hectare) with housing types mainly consisting of detached and semi-detached houses. There is a generally linear urban form running east-west along the River Poulter with some exceptions around the residential streets to the north. The urban grain surrounding Main Road and Queens Walk is loose and sporadic due to the variety of architectural styles. Some buildings front directly onto the street, whilst several are set back providing variety within the streetscape.

The residential streets of Fairfield Close follow a more uniform pattern of semi-detached homes set back by front gardens. Given that most buildings are either one or two storeys high, there is a consistent rhythm of roofscapes across the village. Many of the historic buildings front directly onto the street, whereas many of the 20th century houses give way to front gardens set back behind stone or brick walls.

Nether Langwith's urban grain contrasts with the neighbouring villages of Whaley Thorns and Langwith, with the former mainly consisting of back-to-back Victorian terraces and the latter mainly consisting of wide 1920s/30s terraces.

The approved planning application at land to the south of Portland Road (ref: 16/01216/FUL), as stated in the approved plans, proposes a density of 21dph.



Figure 33: Organic pattern of development: low density



Figure 34: Modern development: low to medium density

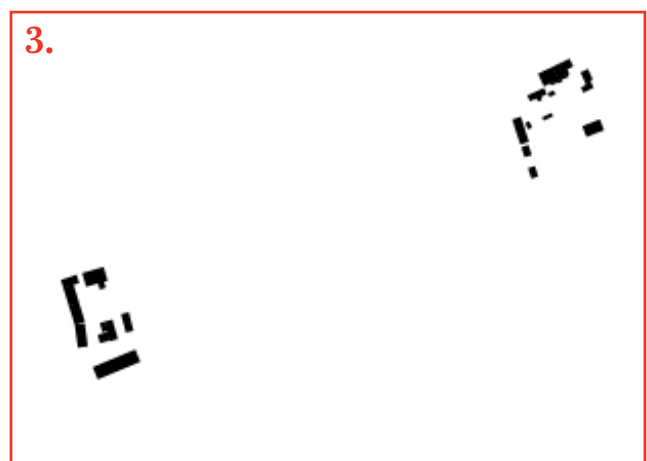
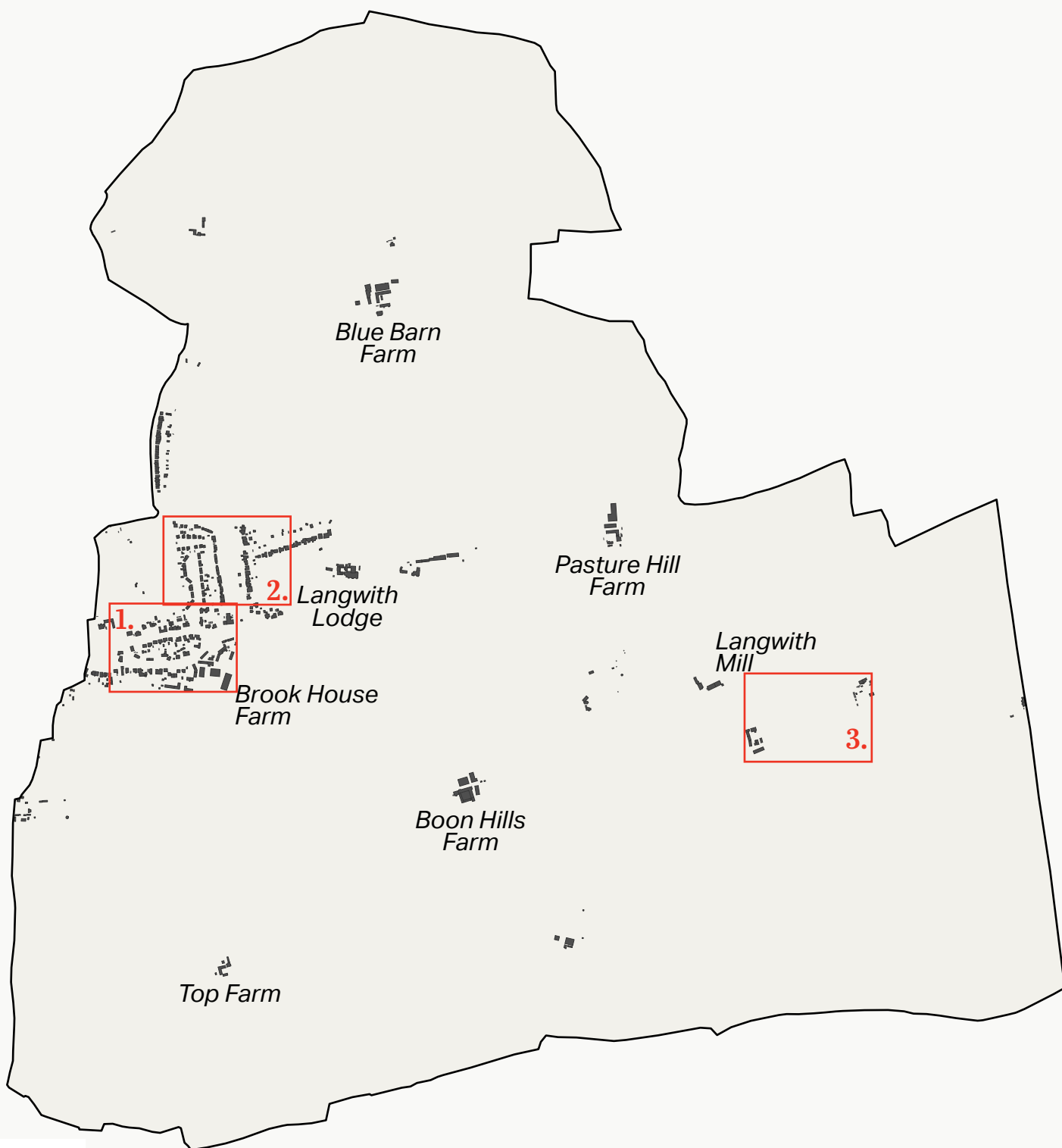

Figure 35: Agricultural development (farmsteads): Low density



300m

Figure 36: Figure ground plan and farms in the Nether Langwith Parish area

scale 1:15000

2.8.1 House Types

The historic buildings of Nether Langwith, such as the local farmsteads and the Jug & Glass Inn, are generally characterised by local building materials such as limestone and red clay roof-tiles. The bricks and stone were supplied locally from a clay pit at Boon Hills Farm and a quarry near Blue Barn Farm.

The 20th century and 21st century houses include a variety of detached and semi-detached homes and bungalows generally without any architectural nods to the historic buildings. There is a lack of uniformity amongst these newer houses, some built of brick and some built of stone of varying colours. Certain newer developments such as the houses on Farm Court attempt to conform with the historic buildings by incorporating sympathetic building material and red roof-tiles.



Figure 37: Roofscape rhythm in Nether Langwith



Figure 38: Semi-detached housing on Fairfield Close



Figure 39: Colholm, Queens Walk

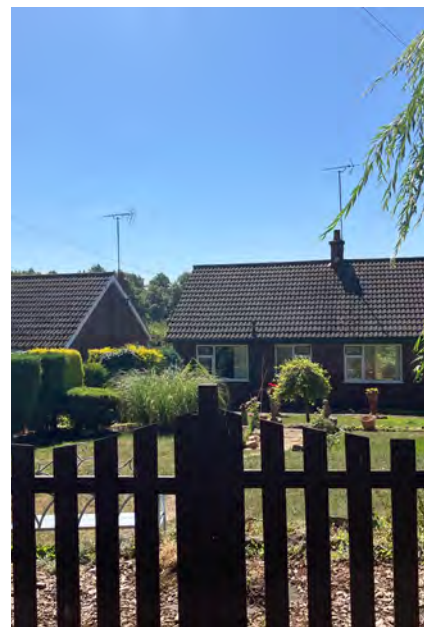
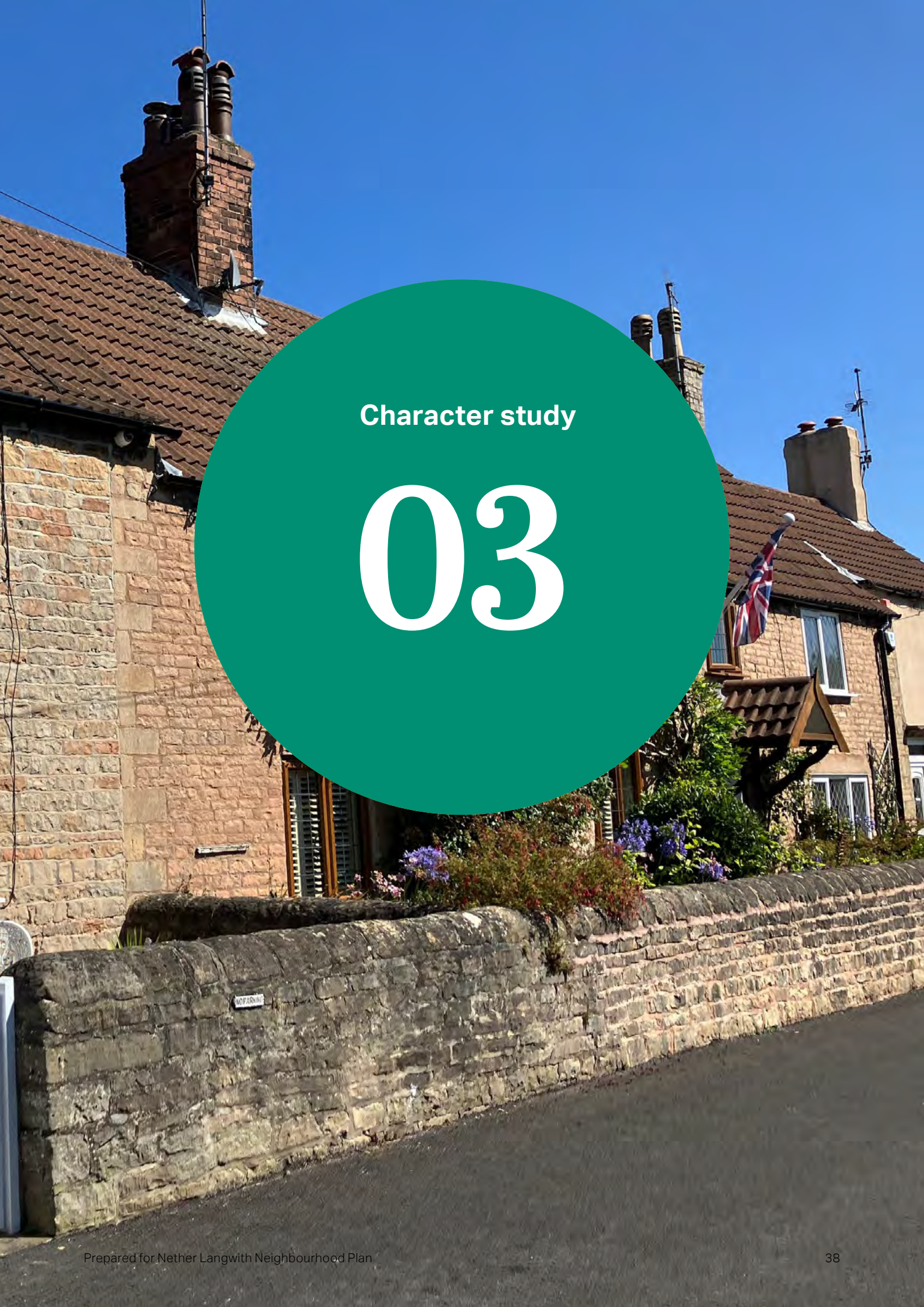

Figure 40: Housetypes in Nether Langwith



Character study

03

3. Character study and area guidelines

This chapter builds upon the previous analysis of the Neighbourhood Area and presents a series of character areas within Nether Langwith. Summary design guidelines are set out for each character area.

A detailed study of the Conservation Area (as a focus area), follows on to highlight examples of what makes this area distinctive.

The attributes identified in this chapter can inform infill development in these areas and can serve as guidance or inspiration for future developments.

3.1 Villagescape and landscape identity

A primary purpose of this Design Guidance and Codes is to help generate sensitive and characterful design responses to the existing settlement area and its landscape setting.

The character analysis that is presented helps understand both the landscape setting and the detailed pattern of settlement growth that underpins the varying appearances across the area.

Each character area may require a subtly different design detail response regarding infill sites, regeneration, or growth nearby that will be in-keeping with each specific local context within the Neighbourhood Area.

The Neighbourhood Area should continue to acquire new layers with design approaches and concepts that are innovative and look to meet future challenges of sustainability and biodiversity net gain. However, these responses must still seek to tie in with the landscape and villagescape character that gives each area its distinctive identity.

3.2 Character areas

The adjacent plan illustrates Nether Langwith's overarching landscape and villagescape character areas as defined in this study based on analysis of topography and landform, housing typologies, materiality and landscape features.

There are certain areas within Nether Langwith that are particularly distinct or important, principally the Conservation Area.

4 distinct character areas have been identified through this study (2-4) including the Conservation Area focus area (1). An additional, broader, character area (5) includes neighbourhoods that lie directly adjacent to the Neighbourhood Area. Whilst this document cannot influence design here, their appearance, scale and materiality should be considered when developing in these locations due to their proximity.

1. Nether Langwith Conservation Area (Focus Area)

The Nether Langwith Conservation Area follows the River Poulter extending across the Neighbourhood Area in an east-west direction along Main Road.

The Conservation Area was designated in June 2010 and is focused on the historic core of the village, including Queens Walk and Main Road, which possesses an attractive character, especially at the Green. The Conservation Area also includes Langwith Lodge and the historic Langwith Mill located to the east of the main built-up area.

2. Fairfield Close

The Fairfield Close Character Area comprises the residential area between Fairfield Close and Limes Avenue, to the north of the Conservation Area.

It contains post-war semi-detached dwellings arranged across a linear street pattern.

3. Portland Road

The Portland Road Character Area is a small area of residential dwellings to the north of the Neighbourhood Area

It contains up to 30 terraced dwellings arranged to front Portland Road with rear boundaries abutting the wider landscape.

4. Welfitt Grove

The Welfitt Grove Character Area lies to the north of the village centre and abuts Langwith Lodge. It is arranged across Limes Avenue and Welfitt Grove. It contains predominantly detached residential dwellings surrounded by mature trees and open fields.

5. Adjacent neighbourhoods

Due to the nature of the Bassetlaw administrative boundary, some settlements are split by the neighbourhood boundary. This section will explore the common characteristics of these neighbourhoods which will aid in guiding development in these locations.

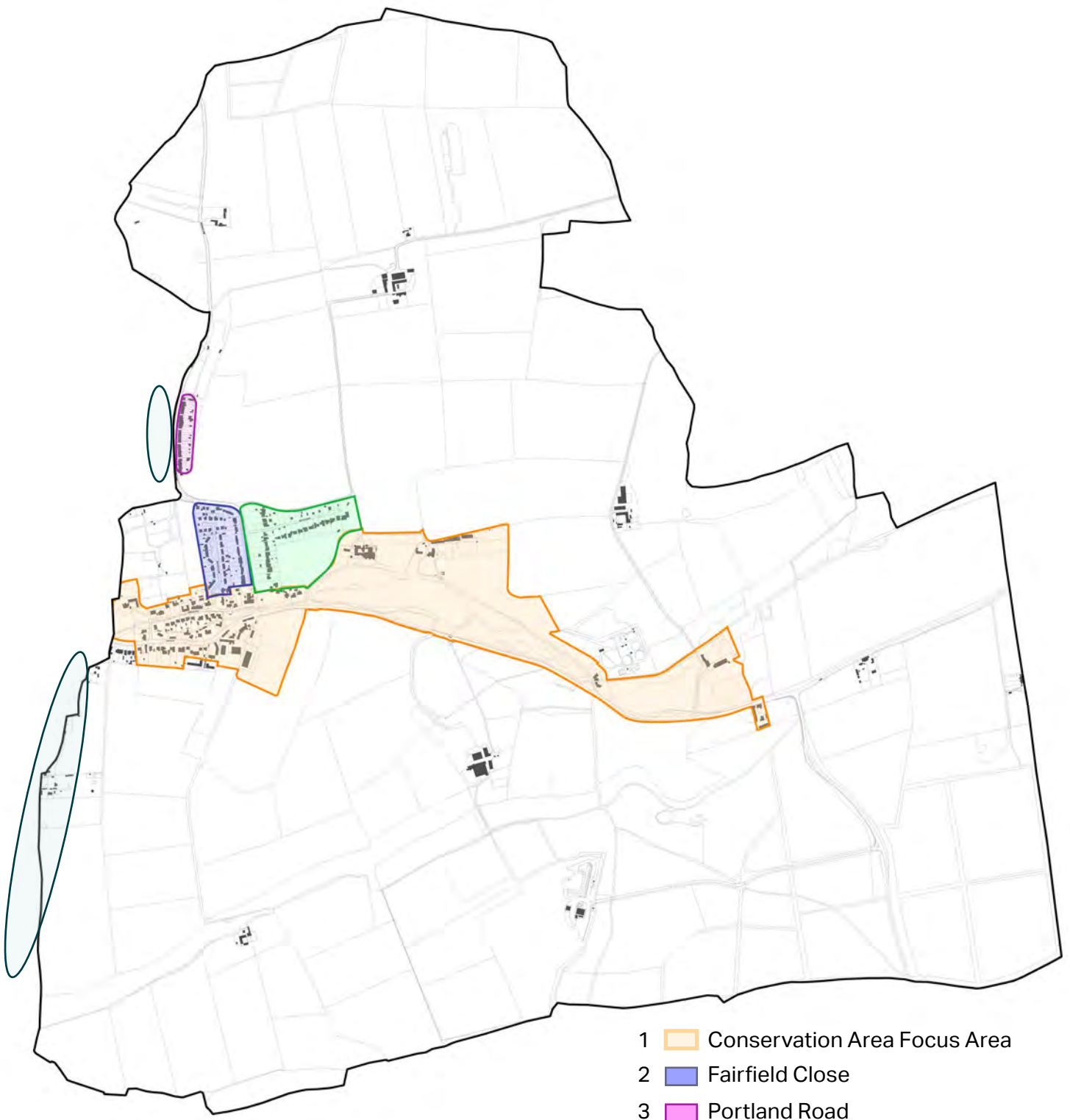

- 1  Conservation Area Focus Area
- 2  Fairfield Close
- 3  Portland Road
- 4  Welfitt Grove
- 5  Adjacent neighbourhoods

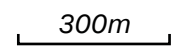
 300m

scale 1:15000

Figure 41: Nether Langwith Character Areas

01

Character Area 1: Conservation Area Focus Area

3.3 Conservation Area: Focus Area

Conservation Areas exist to manage and protect the special architectural and historic interest of a place - in other words, the features that make it unique. They are worthy of special focus as they contribute greatly to the identity of the Neighbourhood Area.

Character summary

This focus area comprises the historic heart of Nether Langwith. The village green, which sits on the River Poulter, forms the main central feature of the character area and is bounded by two small streams that form the River Poulter. The green also includes a war memorial, a 19th century sheep wash, and mature trees.

Key features include:

- Mainly a 18th and 19th century character.
- Strong relationship with the wider rural and historic character.
- Limestone and slate are the predominant elevational and roofscape material.
- Close-knit urban form arranged across an organic street pattern.
- Langwith Lodge and Langwith Mill comprises a distinct character to the east of the village:
 1. Langwith Lodge - a large red brick Victorian building within a manicured landscape adjacent to the river
 2. Langwith Mill - C18 mill building within a rural setting adjacent to the river



Figure 42: Stone Cottage on the junction of Main Road and Queens Walk

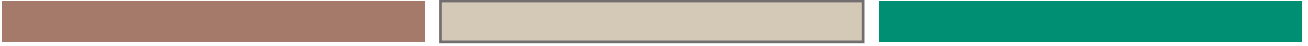

Figure 43: The Jug and Glass pub occupying a central location in Nether Langwith



Figure 44: Historical features are common in the Conservation Area.

Colour palette



Materials and details



Boundary treatments

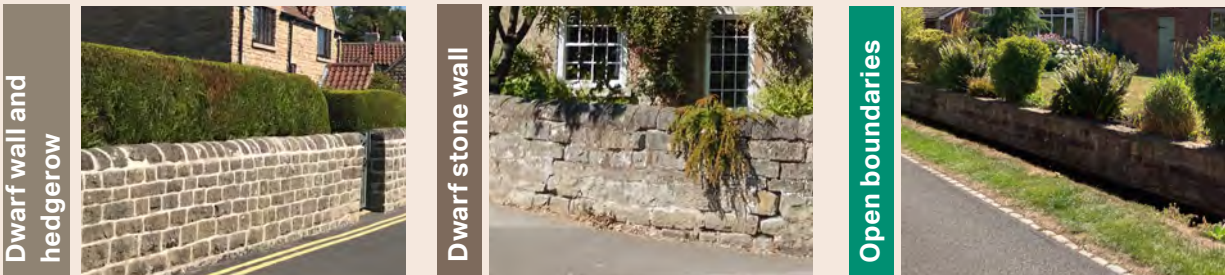

Public realm



Density	The density across the Conservation Area varies due to the extent of the boundary area. At the heart of the village at Queens Walk and Main Road, the density is approximately 10-15 dph with many detached dwellings within medium to large plots. The density drops significantly to the east of the Conservation Area where the isolated buildings of Langwith Lodge and Langwith Mill reside within the wider landscape.
Layout and landscaping	Landscaping (both hard and soft) constitute an integral feature of the Conservation Area. The Green at the heart of the Conservation Area is an important landscape asset, both historically and visually. It is a relatively large green space that contains mature trees, amenity space and the River Poulter (split into two streams that bounds the green space). Mature hedgerows and tree planting are a key feature, comprising strong boundary treatments along Queens Walk and contribute to a Sylvan character. Langwith Lodge resides within a manicured landscape setting containing a large body of water and decorative tree planting and Langwith Mill sits within a cluster of mature trees.
Scale and massing	The scale of buildings varies significantly across the Conservation Area. Residential dwellings in the centre of Nether Langwith are a mix of 1-2 storeys comprising both detached and terraced properties. Langwith Lodge is a large 3 storey property whereas Langwith Mill extends to 4 storeys.
Materials	Limestone and slate are the predominant elevational and roofscape material.
Detailing and Openings	Detailing is limited across the Conservation Area. Openings typically comprise timber framed sashed windows with many examples of lattice patterns on the older properties. Many newer dwellings include standard white uPVC window frames.

Design guidance to define and enhance the character and identity of the Conservation Area

- **Boundary treatments must include a mix of dwarf wall, hedgerow and trees within hedgerow planting to delineate between public and private space.**
- **To be in-keeping with the prevailing character of the Conservation Area, new buildings must specify limestone for the elevational treatment and slate for the roofs.**
- **Parking must be provided on-plot to not exacerbate on-street parking and the narrowing of streets and spaces.**
- **New buildings adjacent to the Green must provide an active frontage through appropriate scale, openings and orientation to overlook the space to provide a strong degree of natural surveillance.**
- **Construction or modifications to a property will be subject to rigorous planning controls and must be in-line with the design codes set out in chapter 04.**



Figure 45: Features within the Conservation Area

02

Character Area 2: Fairfield Close

3.4 Fairfield Close

Summary character

The Fairfield Close Character Area is wholly residential in use. The single block of development is arranged across a linear street pattern comprising Fairfield Close and Limes Avenue.

The density of this character area is between 20 and 25 dph and is characterised by mainly semi-detached, post-war housing. There are also a number of detached dwellings towards the north of the character area (south of Portland Road). There are also examples of single storey semi-detached bungalows along Fairfield Close.

Whilst there is a relative uniformity of housetypes, brown brick with brown slate roofs are the dominant elevational and roof treatment. The materiality of residential properties along Limes Avenue vary slightly with a light brown / cream brick.

Front boundary treatments vary significantly between hedgerow, fencing and open boundary treatments.

The uniformity of the roofscape, building scale and orientation, alongside grass verges along the frontage provide significant visual relief along the streetscene, specifically along Limes Avenue, creating an attractive pedestrian environment and providing a degree of overlooking and natural surveillance.



Figure 46: Limes Avenue - grass verges and on-street parking.



Figure 47: Terraced properties along Fairfield Close with mixed boundary treatments

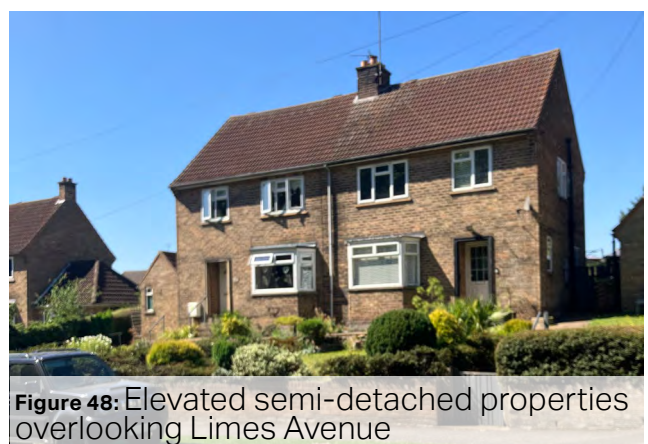

Figure 48: Elevated semi-detached properties overlooking Limes Avenue



1. Brown concrete pantile roofing with standard pitch
2. White uPvc window casings overlooking the street
3. Two storey semi-detached with brown/cream elevational treatment
4. Dwarf wall and hedgerow boundary treatment
5. Grass verge providing visual relief



1. Brown flat tile roofing with standard pitch
2. Two storey semi-detached with red and brown brick elevational treatment
3. Open boundary treatment with on-plot, front of property parking
4. Fencing to delineate between public and private space
5. Mix of fencing and hedgerow boundaries

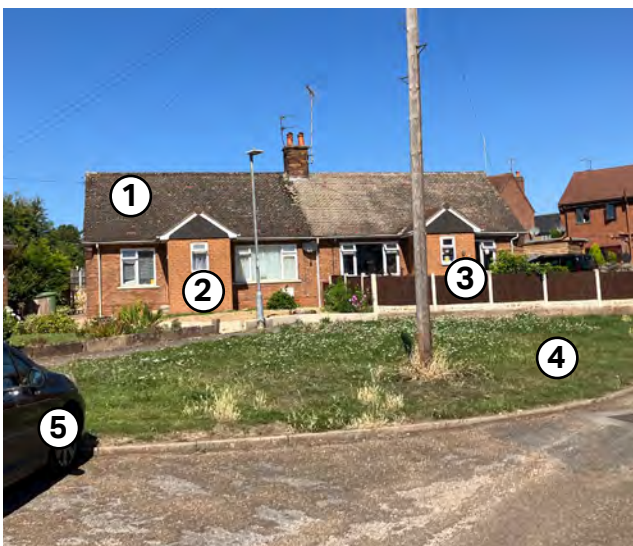

1. Brown flat tile roofing with standard pitch
2. Single storey bungalow with red/brown elevational treatment
3. Mix of fencing and open boundaries
4. Grass verge providing visual relief
5. On-street parking

Design guidance to define and enhance the character and identity of Fairfield Close:

- **Boundary treatment that promote a positive relationship with the street. Low, open or vegetated boundaries are preferable.**
- **Be of an appropriate scale, ideally two storeys with joining walls on one side, or both.**
- **New buildings to be orientated to front the street to provide passive surveillance through overlooking.**
- **Encourage on-plot parking, either to the side or front of property to avoid parked cars dominating the streetscene.**

03

Character Area 3: Portland Road

3.5 Portland Road

Summary character

The Portland Road Character Area comprises a small number of residential properties and forms part of a wider neighbourhood that does not fall within the Nether Langwith neighbourhood boundary.

The wider neighbourhood has a mixed character with a mix of red brick and pale stone elevational treatments. Boundary treatments vary but properties are mainly bounded by dwarf walls with a few examples of hedgerow.

The terraced properties within the Nether Langwith boundary are two storeys with red brick in a garden wall bond. Boundary treatments reflect the wider character with a number of dwarf brick walls promoting a positive relationship with the street.

The roofscape comprises a mix of slate flat and pantile roofing treatments with a standard pitch. The uniformity of the treatment, alongside the strong level of enclosure through active frontages, low boundary treatments and fenestration, provide passive surveillance through overlooking.

Properties have a small building line setback which means parking cannot be provided on-plot. Parking is therefore provided on-street which significantly narrows Portland Road. This exacerbates congestion along Portland Road which experiences high traffic movement and accommodates the bus network.

Other features in the character area (and the wider neighbourhood) include an area of greenspace, shops and services (post office, medical centre).



Figure 49: Area of public open space that lies within the adjacent Neighbourhood Area

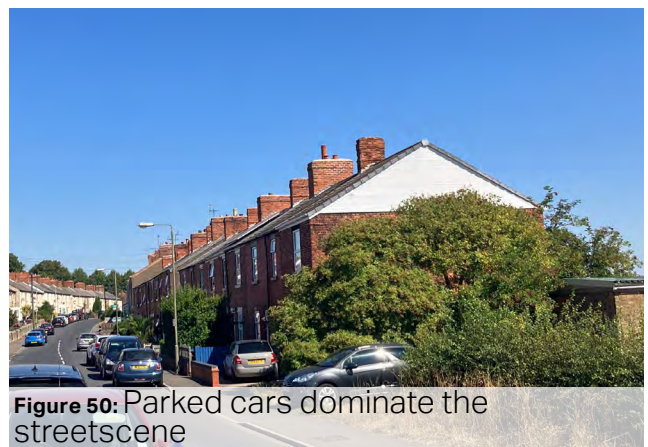
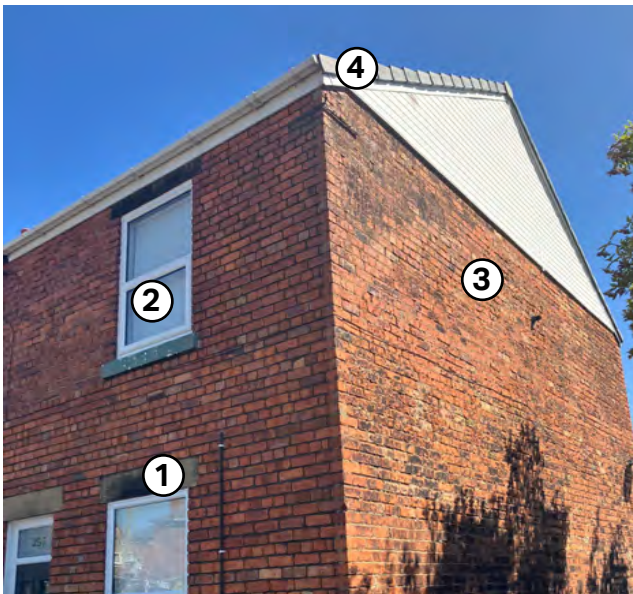

Figure 50: Parked cars dominate the streetscene



Figure 51: Mixed boundary treatments along Portland Road



1. Stone sills and lintels
2. White uPVC window casings overlooking the street
3. Red and brown brick in a garden bond
4. Standard gable roof pitch with slate roofing materials



1. Slate or brown pantile tiling with standard gable pitch
2. Two storey semi-detached with red and brown brick elevational treatment
3. Open or low boundary treatments with on-street parking
4. Fencing to delineate between public and private space
5. Mix of fencing and hedgerow boundaries



Portland Road (looking northwards). The image above illustrates the issue of parked cars on the street which significantly narrows the road, constraining traffic flow along this arterial route.

Design guidance to define and enhance the character and identity of Portland Road:

- **Promote a positive relationship with the street through scale, openings and low boundary treatments.**
- **Be of an appropriate scale which is typically two storeys.**
- **New buildings must have joining walls on both sides (terraced buildings).**
- **New buildings to be orientated to front the street to provide passive surveillance through overlooking.**
- **Encourage on-plot parking, either to the side or front of property to avoid exacerbating the existing problem of parked cars on a busy road.**

04

Character Area 4: Welfitt Grove

3.6 Welfitt Grove

Summary character

The Welfitt Grove character area is arranged across two streets; Welfitt Grove and Limes Avenue and predominantly comprises detached 1 and 2 storey properties at a density of approximately 16 dph.

Residential properties typically sit within large plots, with a significant setback from the road.

There is a significant number of mature tree planting including Poplars, Lime, Maple, and Willow among others which all contribute to a sylvan character.

Boundary treatments vary, properties fronting Limes Avenue are bounded by a stone wall with a corridor of trees screening residential dwellings. Properties fronting Welfitt Grove however, are bounded by picket fencing and hedgerow, surrounded by a variety of tree planting, reinforcing the wooded character.

Due to the screening provided by strong boundary features and tree planting, parked cars are not visible from the street.



Figure 52: Change in surface material to delineate between public and private space



Figure 55: Significant tree planting contributing to a sylvan character



Figure 53: Welfitt Grove. No natural surveillance along this section of road



Figure 54: Garages isolated from the associated dwelling



1. Picket fencing setback behind a grass verge
2. Dwellings setback from the road
3. Tree planting underpinning the boundary treatment



1. Two storey detached dwellings
2. Red/brown brick elevational treatment
3. Mature tree planting
4. A long driveway significantly setback from the road



1. Two storey detached property
2. Red/brown brick elevational treatment
3. A long driveway significantly setback from the road
4. Mature tree planting

Design guidance to define and enhance the character and identity of Welfitt Grove:

- New development must be significantly setback from the road behind strong boundary features such as fencing, hedgerow or a stone wall.
- Proposals must be underpinned by a comprehensive soft landscape scheme that proposes the planting of trees.
- Where appropriate, boundary lines must be setback behind a grass verge to provide visual relief on the streetscene.

05

Character Area 5: Adjacent neighbourhoods

3.7 Character of adjacent neighbourhoods

Summary

Due to the nature of Bassetlaw's administrative boundary, many of Nether Langwith's properties form part of a wider neighbourhood that does not fall within the Neighbourhood Area. This section will identify the prevailing characteristics of nearby neighbourhoods which may influence the character areas discussed above. The Codes set out in this document can only apply to development within the Neighbourhood Area.

1. Portland Road

- Predominantly terraced properties
- Predominantly red brick elevational treatments with slat roofing
- On-street parking



2. Langwith Drive / Devonshire Drive

- Mix of inter-war housing including detached, semi-detached and terraced properties
- Mixed boundary treatments. Primarily hedgerows and dwarf walls
- On-plot parking



3. Devonshire Drive / Langwith Drive

- Terraced and semi-detached housing
- Mix of red brick and brown pebble-dash elevational treatments. Examples of pale rendering
- Hipped roofs with pantile and flat tiling
- Typically front of plot parking



LANGWITH Neighbourhood Area



Figure 59: Properties and greenspace opposite Portland Road CA



Figure 57: Detached property on Langwith Drive (east)



Figure 58: Terraced properties on Devonshire Drive (east)



NETHER LANGWITH Neighbourhood Area

Figure 56: Figure ground plan of the Nether Langwith and Langwith administrative boundaries



Design Codes

04

4. Design guidance & codes

This section sets out the principles that will influence the design of potential new development in the Neighbourhood Area. Where possible, local images are used to exemplify the design guidelines and codes. Where these images are not available, best practice examples from elsewhere are used.

4.1 Introduction

This section illustrates a series of design codes which will apply to all new developments across Nether Langwith, setting out requirements that relevant planning applications in the Neighbourhood Area will be expected to address. The codes build upon the design guidance considerations set out in chapter 03 which focus on the identified character areas across the Neighbourhood Area. The design guidance set out in chapter 03 is specific to planning proposals within the identified character areas. The codes within this chapter will apply to all new development across the entire Neighbourhood Area.

The design codes in this chapter, and the guidance set out in the previous chapter will provide the context and direction for all new development, whether on major development sites (that come forward in the future), infill and back land development and provide detailed guidance of topics of local concern.

4.2 Code topic areas

The following topics are addressed by design codes in this section.

A. Character and Heritage (4.3)

- A1. Landscape setting and rural settlement identity
- A2. Character and quality of development
- A3. Responding to heritage

B. Housing, design, and quality (4.4)

- B1. Quality, type, and scale
- B2. Appearance
- B3. Extensions and alterations
- B3. Affordable housing
- B4: Infill Development

C. Sustainability and energy (4.5)

- C1. Future homes standard towards zero carbon
- C2: Assessing alternative energy sources
- C3. Micro-climate and resilience
- C3. Building orientation and passive design

D. Green and Blue infrastructure (4.6)

- D1. Biodiversity
- D2. Landscape and Green Infrastructure
- D3. Water sensitive urban design



Design Code A: Character and heritage

4.3 Character and heritage

Many of Nether Langwith's buildings abut the countryside where the low lying topography and landscape features allow for long distance views towards the village.

In many cases, the interface between the rural and urban environments is characterised by rear and side building elevations. This fails to visually assimilate the built form into the wider landscape setting.

Furthermore, Nether Langwith has a number of listed assets and an extensive Conservation Area that includes the majority of the urban area, particularly the village centre, along Main Road and Queens Walk.

The codes within this section will therefore seek to ensure that new development is contextually responsive to their setting, whether integrating into the landscape through appropriate orientation or enhancing the setting of a listed asset through the framing of key views.



A1 -Landscape setting and rural settlement identity

Development proposals that are located on settlement edges must:

- Ensure dwelling frontages are orientated outwards and avoid rear boundaries facing the landscape - unless suitably screened by planting.
- Retain the visual quality of the landscape by reducing the scale of development; Dwellings should not exceed 2 storeys in these locations.
- Soften the boundary between built form and the wider landscape by encouraging soft landscape planting such as hedgerow, wildflower, and tree planting.
- Provide links for both pedestrians and cyclists to the wider countryside, and where possible, connect to the Public Right of Way network.
- Avoid designing a street hierarchy that arranges primary roads and over-engineered turning heads to abut the wider landscape.
- Be of a low density with buildings interspersed with tree planting to visually soften the impact on the surrounding countryside.



Figure 60: Properties sensitively sitting within the wider landscape setting. This is achieved through building at an appropriate scale accompanied with boundary planting.

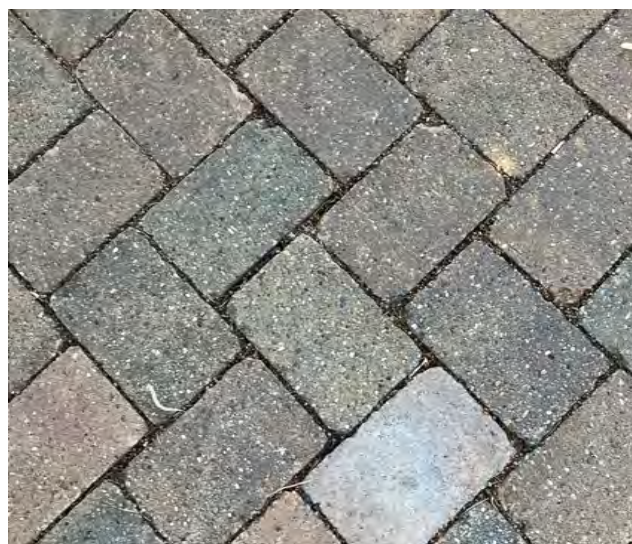

Figure 61: Change in surface materials on turning heads can soften the impact of roads when in proximity to the settlement edge

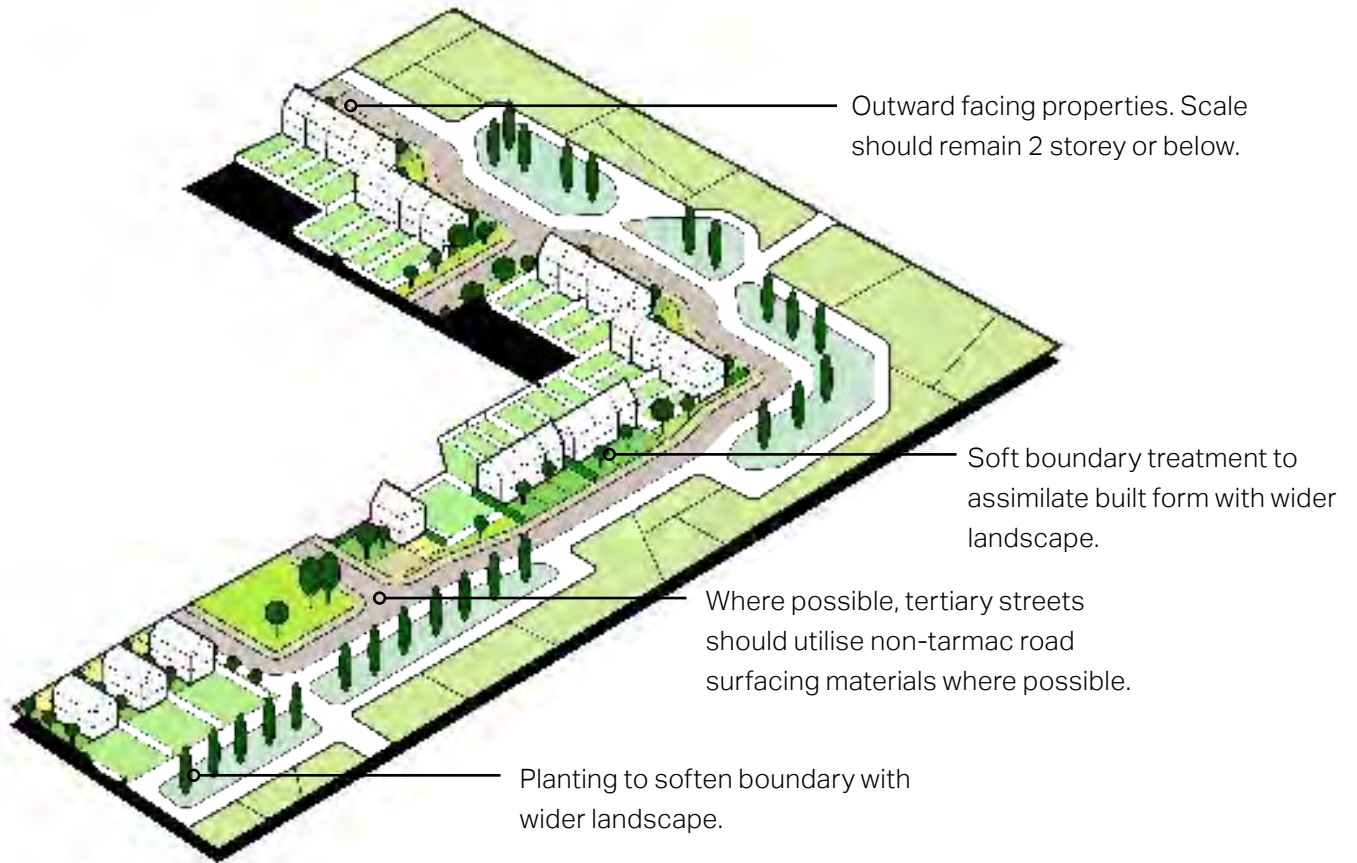

Figure 62: Outward facing two storey properties behind vegetated boundaries.



Figure 63: Change in surface materials and colours delineating between primary, secondary and tertiary streets.

A2 - Character and quality of development

A core objective of the Design Guide and Codes document is to retain the character and quality of Nether Langwith through encouraging contextually responsive design proposals. This can be achieved by following the below codes:

- **Plot boundary treatments must define public and private space and add to the definition and sense of ownership along streets.**
- **Boundaries of low stone walls or hedgerow planting must be used on primary access streets.**
- **Open boundary typologies or closed board fence should not face public spaces.**

EXCEPTION: Open boundary treatments are acceptable where identified as a characteristic in chapter 03 (i.e. bungalows along Queens Walk)

- **Materials and style of new homes should be responsive to local character in conception with consideration for local styles and the materials.**
- **Sympathetic styles of architecture should be presented when facing existing traditional properties of the village and rural edges.**

- **Innovation in materials and construction techniques may be appropriate if achieving considerable sustainability credentials but must be attractive and sympathetic to local styles and guidance for the Conservation Area.**
- **Building facades should provide enclosure and an active frontage along the street.**
- **Requirements for parking should not undermine the attractiveness of the streetscene. Cars should be integrated sensitively into the street scene and screened from view by buildings and property boundaries and soft landscaping.**
- **Parking should be fully integrated within the plot either to the side, or to the rear of the property to avoid impacting the quality of the streetscene and public realm.**
- **Parking to the front of the property will be limited along short runs so as to not visually dominate the streetscene.**
- **Parking on street in new developments should be managed carefully by providing visitor parking in defined areas.**



Figure 64: Boundary materials should aim to reflect the materials and colour of the related property and the character area in which it resides. The characteristics of each character areas are set out in chapter 03.



Figure 65: Within the Conservation Area, materials and colours on new building facades and roofs must be in-keeping with those set out in character area 01.



Figure 66: New developments must avoid on-street car parking to not diminish the visual quality of the street.

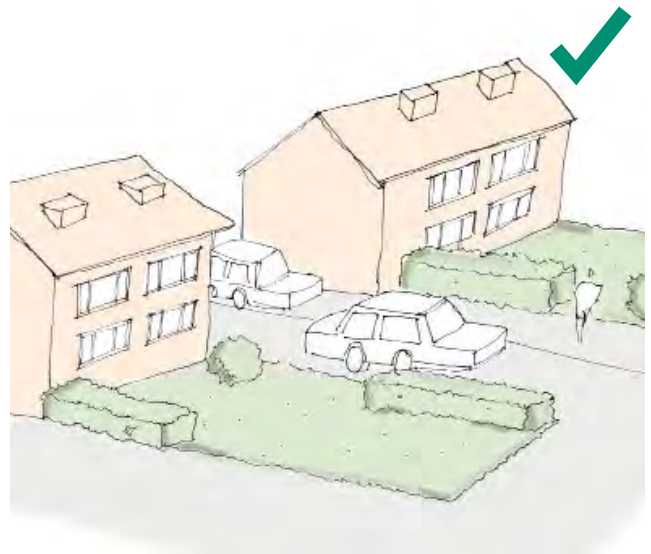

Figure 67: Side of property parking will hide vehicles from sight, improving the visual quality of the street.

A3 - Responding to heritage

Nether Langwith has an extensive Conservation Area and several important historical assets within the Neighbourhood Area which all contribute to creating an attractive environment.

The following codes, notwithstanding the provisions set out in Character Area 01 (chapter 03), will focus on ensuring future development proposals will contribute positively to the many listed buildings and Conservation Area.

A3 – Responding to heritage: (a) Nether Langwith Conservation Area

The Nether Langwith Conservation Area extends across the Neighbourhood Area and comprises a number of residential properties and open spaces including the Green and the river Poulter. There is no relevant Conservation Area Appraisal document for new development to consider, therefore new buildings and alterations to existing properties will be required to consider the provisions set out in Character Area 01 (chapter 03) in this document and the following design codes:

- Any development must retain areas of positive character by retaining as much historic fabric as possible, including built

form, floorscape, landscape and mature planting.

- Any development should respect the historic layout and pattern of the Conservation Area, responding to positive characteristics in terms of street pattern, density and layout, plot series and boundary treatments.
- Respond to heritage features, such as reflecting materials, detailing and openings whilst avoiding pastiche design which detracts from the appearance of the historical character.
- Respond appropriately by respecting scale, massing, and height, especially where visible from public routes and spaces (particularly the main routes through the village).
- Retain and frame key views of listed assets and notable buildings.
- New buildings should be orientated and sited where it does not impact the setting of a listed asset.
- Avoid dormers that significantly alter the roofline.

A3 - Responding to heritage: (b) Listed Buildings

There are 12 listed assets within Nether Langwith. The majority of these assets are located within the boundary of the Conservation Area, and 8 of which are located in the village centre. New development

or alterations to listed assets, or adjacent to listed assets, or within the setting of listed assets, must consider the following codes:

- Ensuring that windows and door design are proportioned and designed to reflect the style/ age of the surrounding heritage buildings.
- Adopt materials that are set out in Character Area 01 (chapter 03) and those illustrated in code B2 and page 67 of this document.
- Reuse of old materials from traditional buildings should be used where possible when carrying out alterations and extensions.
- Rooflines and styles should reflect those within the locality
- Materials and architectural styles applied by new developments must respond to local character and the significance of the listed building and its setting.
- Development within the setting of listed buildings should relate appropriately in terms of siting, scale, storeys heights and massing.

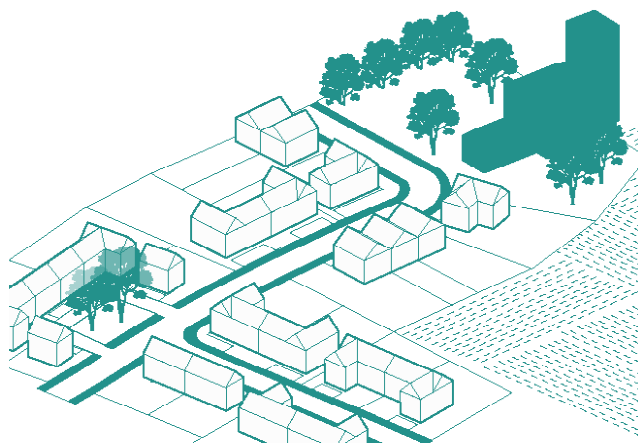

Figure 68: Views to local landmarks and listed buildings should be retained, acting as visual links to aid orientation and retain area characteristics. New developments should respect the existing shape and rhythm of roofscapes and designers should make sure that new buildings do not obstruct views to local landmarks such as the Green, listed buildings such as those on Queens Walk and Main Road.



Figure 69: Properties on Queens Walk in the Conservation Area



Design Code B: Housing, design and quality

4.4 Housing, design, and quality

New residential development within Nether Langwith should seek to achieve high quality design whether it is on small developments such as infill or back land sites, or major development sites that come forward in the future.

This section will provide design codes to ensure proposals are in-keeping with the prevailing local character and assimilate with the wider villagescape and landscape with regards to building type, scale, and appearance.

A detailed analysis of Nether Langwith's character is set out in chapter 03 of this report. Subject to location, development proposals must also respond to the characteristics and design guidances set out in that chapter.

B1 - Quality, type, and scale

At the outset, development proposals must identify the relevant character area in which they reside (as identified in chapter 03) and address the specific design guidance set out within that chapter. Notwithstanding the provision sets out in chapter 03, all new development including alterations and extensions should address the following design codes:

- **Building scale and massing should be in keeping with the prevailing village pattern and not be overbearing on existing properties or deprive them of light, including overlooking or over-shadowing of both windows and amenity space.**
- **Building scale and position on plot should help to define and enclose the space within the street corridor to an appropriate degree based on the existing street section (building to building) and level of enclosure (ratio of street width to building height).**
- **Building height should vary between 1.5 and 2 storeys. At key corners, scale can increase to 2.5 to create focal points.**
- **Within residential neighbourhoods and at development edges building scale should not exceed 2 storeys to assimilate the development with the wider surroundings.**

- A variable eaves and ridge line should be encouraged to provide variation in the roofscape and streetscene but should not significantly depart from the prevailing local character. Typically, variation between adjacent buildings should be a maximum of 0.5 storeys.
- In line with the information set out in chapter 3, the default building line should be setback from the pavement and be in-keeping with adjacent plots and should be behind an appropriate boundary treatment that is also reflective of the adjacent plots. Tree and hedgerow planting within residential curtilages should be encouraged where appropriate.
- Front of plot areas and rear gardens should be of sufficient size and landscaped appropriately to fit in with prevailing planting pattern or to enhance to the green character of the area where it is lacking.
- Rear or side plot boundaries which face public spaces must be masonry walls of an appropriate material and have sufficient overlooking to match adjacent plots and add to the streetscene quality.
- Access and storage for bins should be provided and bin stores should be designed to be integrated with plot boundaries. Ginnels should be considered for terraced buildings with 4 or more units in order that bicycle and bin storage to the rear can be satisfactorily brought to the front.

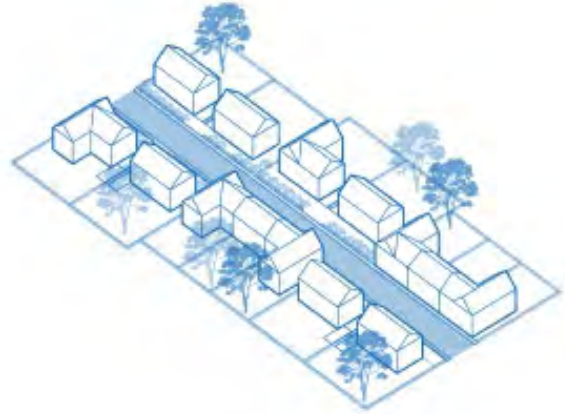

Figure 70: The default building line should be setback from the pavement behind an appropriate boundary.

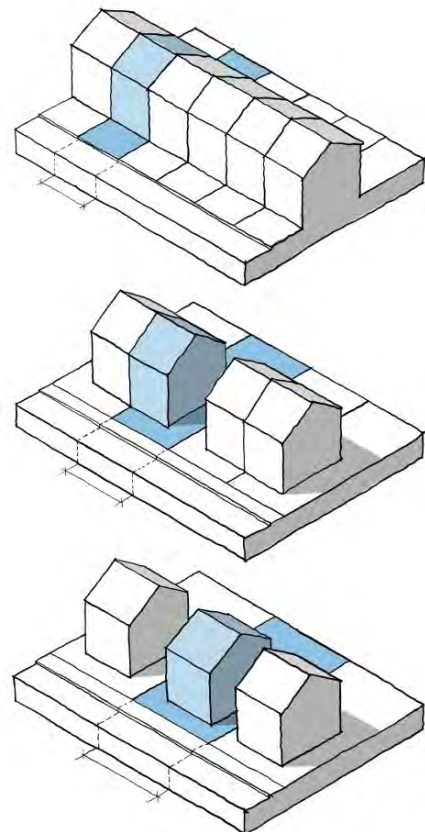

Figure 71: In general, new building scale should reflect the scale, orientation and massing of adjacent properties. At focal points and key corners, the scale of the property may increase to 2.5 storeys to articulate these key locations.

B2 - Appearance

Development within the identified character areas must consider the design guidance set out in chapter 03. Notwithstanding these criteria, all development across Nether Langwith must:

- **Be orientated to face the street to provide a degree of overlooking and natural surveillance to streets and the public realm. Building on key corners should seek to provide an active frontage (doors / fenestration) on both sides to improve site and village legibility.**
- **Provide fenestration and patterns that are in-keeping with the predominant positive buildings character on the street or harmonise with adjacent buildings of good character.**
- **Create a façade design that respects the horizontal rhythm of plots and building subdivisions on the street to integrate and maintain visual continuity or add to the visual interest where required.**
- **Use materials that reflect positive local characteristics and harmonise with adjacent buildings with matching or complementary materials, subject to the degree of variety in the village / area / street.**
- **Provide fenestration proportions (i.e., ratio of solid to void and verticality) that respond to the existing character of the building.**

B3- Extensions and alterations

- 1. Extensions to existing properties should be of appropriate scale in relation to the original building.**
- 2. Extension to the front of the property should be avoided as this may compromise visual cohesion with the street frontage.**
- 3. Extensions to historic buildings, or within the setting of listed assets, should be sympathetic and respond sensitively to the original character of the building or nearby listed assets. Material palettes and style of the extension should be carefully chosen to blend cohesively with the original form and features.**
- 4. Extensions must not exceed a 45 degree splay from the centre of the window of the nearest habitable window of an adjacent window to avoid a reduction in daylight.**

Colour palette



Roofing



Openings



Materials

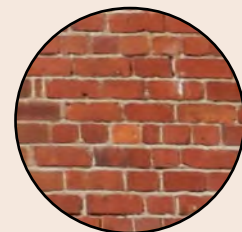

Figure 72: Boundary walls supported by hedgerow delineating between public and private space



Figure 73: Stone boundary walls delineating between public and private space

B4 - Affordable housing

- **Proposals for affordable housing should be in-keeping with the prevailing character of the neighbourhood by reflecting the materiality, colour, scale, form, and massing of adjacent properties.**
- **Affordable units that comprise a part of major development sites should be integrated or 'pepper potted' throughout the scheme to avoid creating cluster development.**
- **Encourage sympathetic boundary treatments that is in-keeping with adjacent plots.**
- **Promote a Lifetime Homes standard of build, or specifically built for disabled use.**
- **Parking should be provided on-plot or nearby within a courtyard.**
- **Dual aspect homes should be provided wherever possible. North facing, single aspect properties will not be acceptable.**

B5 - Infill Development

Guidelines for infill development in Nether Langwith are as follows:

- **Materials should reflect the character area and harmonise with adjacent homes (see chapter 03 Character Study).**
- **Fenestration and facades should be in keeping with the predominant positive buildings character on the street or harmonise with adjacent buildings of good character.**
- **Dwelling entrances should front the street with a main access and main fenestration.**
- **The building line should reflect the street and not be setback more than 2m from adjacent buildings. Where buildings are setback from the pavement a masonry boundary wall (usually low-rise) should define the plot and link to adjacent.**
- **Buildings should have a size, scale, and positioning within a plot, that helps to define and enclose the streetscape.**



Figure 75: Here, the new infill development is not sympathetic with the surrounding pattern of buildings. The height and style of the roof breaks up the continuity of the street, the building materials are unrelated and stand out starkly, and the setback disrupts the building line.



Figure 74: Along this street, the repetition of certain building elements such as the openings, porches and building line, creates a visual rhythm. Some variation is acceptable - for example larger windows, roof lights to an attic room, and similar materials but with subtly different detailing. This creates individuality and interest, whilst fitting in well with the surrounding buildings.



Design Code C: Sustainability and energy

4.5 Sustainability and energy

C1 - Future Homes Standard-Towards Zero Carbon

- All new developments in Nether Langwith must demonstrate that they are responding to climate change and reducing carbon dependency. The government's forthcoming Future Homes Standard, including changes to Part L and Part F of the Building Regulations, will aim to cut carbon emissions by 80% in all new homes by 2025.
- For new homes this likely means a 'fabric-first' approach with the highest standards of insulation and energy conservation - roof, wall and under floor insulation, efficient double or triple glazing and airtightness.
- Ventilation with heat recovery, solar panels, ground, and air source heat pumps must be considered alongside smart meters. New housing will demonstrate how rainwater will be stored and reused as grey water to reduce demand on mains supplies.

C2 - Assessing Alternative Energy Sources

The key considerations for an assessment of alternative energy sources for development may include (but are not limited to):

- **Solar orientation of sites and buildings:** Ensure majority of buildings on site are oriented (main façade & roof plane) within 30' of south for solar gain / energy
- **Ground conditions and sufficient space to accommodate ground loops for ground source heat.**
- **Availability of locally sourced wood fuel for biomass heating.**
- **Local wind speed and direction, WSW is the prevailing wind direction for Nether Langwith.**



Figure 76: Integrated PV panels on roof



Figure 77: Air heat pump

C3 - Micro-climate and resilience

All new development should work to moderate extremes of temperature, wind, humidity, local flooding, and pollution within the village. Development must also respond to the combined effects on local micro-climate of the following:

- Identify areas of sites that would be most usable for outdoor amenity space and activity.
- Use trees and boundaries to mitigate and improve micro-climate for outdoor spaces and the public realm.
- Understand solar orientation and exposure (via sun/shade study) - public spaces and gardens should have direct sun over a significant portion of the day (year-round).
- Prevailing winds, direction and speed need assessing- avoiding local wind tunnel effects or capitalising on wind-power via micro-turbines.
- Understanding topography and distribution of buildings to avoid low-lying contained spaces (damp/cold spaces).
- Does not cumulatively exacerbate local flooding issues for neighbouring properties or compromise amenity.
- Create more flexible and adaptable homes that have a long-life and loose fit will make them resilient in terms of a built form that can be re-purposed, adapted and reused over time.

C4 - Building orientation & passive design

The orientation of buildings and roof pitches should incorporate passive solar design principles and allow for efficient solar energy collection. Ideally, one of the main glazed elevations of dwellings should be oriented within 30° of south.

This applies to future dwellings whether solar panels are proposed or not to allow for retrospective implementation. This must of course be balanced with other siting needs and recognition that buildings knit into the village urban fabric to create a coherent pattern of streets and spaces that fits with local character.

The 'long' sides of buildings, terraces or barns will benefit most from this orientation. Similarly, as far as possible, orient buildings across to prevailing winds to generate cross ventilation in buildings. In Nether Langwith prevailing winds tend to be from west-south-west so orientation for both wind and solar access can be combined in particular circumstances.

For those looking to 'push the envelope', there are a further 5 factors (from Passive House design and construction principles):

- Super-insulated envelopes.
- Airtight construction.
- High-performance glazing.
- Thermal-bridge-free detailing.
- Heat recovery ventilation.



Design Code D: Green and blue infrastructure

4.6 Green and Blue Infrastructure

Much of the focus on 'sustainable housing' is on reducing carbon emissions, however, appropriately designed green infrastructure also plays an important role in the sustainability agenda.

It is expected, as stipulated in the Bassetlaw emerging Local Plan (policy ST40), that all new development proposals will achieve at least a 10% Biodiversity Net Gain increase from the pre-development biodiversity value.

This section seeks to set out how new development in Nether Langwith will work with the existing landscape and natural assets whilst achieving the target of 10% net gain in biodiversity.

D1 - Biodiversity

- **The loss of trees, hedgerows and native planting must be avoided where possible and instead these features should be incorporated into the design of proposed development.**
- **All major development must be accompanied by a comprehensive soft and hard landscape scheme which prioritises the incorporation of native species and promotes overall biodiversity net gain.**
- **Aim to develop a multifunctional green infrastructure network made up of a variety of elements: including hedgerow, private gardens, tree planting, grass verges, SuDs, amenity green space, watercourses, cemetery, allotments, orchards, meadows, and playing fields.**
- **New developments must seek to create new habitats through the use of:**
 1. **Integration of 'swift bricks' under eaves.**
 2. **Installation of bird boxes.**
 3. **New native tree planting.**
 4. **Ensure the use of native hedgerows as boundary treatments.**

D2 – Landscape and Green Infrastructure

- Retain existing trees and hedgerows of good quality on the site within verges and in open spaces within the layout of new development.
- Where a new settlement edge is being created, proposals must demonstrate how the built form will transition between the settlements and the wider landscape. Schemes should be designed to avoid a hard edge and instead use reduced building heights, planting and lower densities to achieve a sensitive transition.
- Include generous offsets to boundary vegetation such as hedgerows and provide additional planting on sensitive landscape edges – screen planting may be required on some sites and should be designed in conjunction with results of any landscape and visual impact surveys.

- The appearance, massing and scale of development should be filtered and broken-up by green infrastructure such as open spaces, trees, hedges, and planting.
- Green infrastructure elements should be combined to form a multi-functional green network. Existing and new planting should knit together within this network at a range of scales, with minimal breaks to create connected habitats and routes for wildlife.
- It must be demonstrated that proposed development has been designed to take account of the character of the landscape around and adjacent to it, where relevant, utilising the Landscape Character evidence work available. This may be in terms of the colours and textures used in materials and certainly an influence in the proposed landscape scheme, for example, when proposing vegetative boundary treatments.



Figure 78: Promoting a positive relationship with the wider countryside



Figure 79: Promoting a multifunctional green infrastructure network including verges, hedgerow, gardens, trees and planting

D3 - Water Sensitive Urban Design

As a standard, proposals must promote methods to mitigate increased risk of storms/flooding with sustainable drainage systems.

Development proposals should seek to:

- Integrate sustainable drainage systems to assist with flood alleviation from rivers and drains and surface water runoff and incorporate surface features such as planted raingardens to express this function.
- On minor development sites, proposals must integrate bio-swales and/or rain gardens and/or permeable surfacing in their design to assist with surface water drainage.

- On schemes that propose 10 or more dwellings, proposals must integrate bio-swales and/or attenuation basins in their design. These must be planted with wildflower planting to assist achieving a biodiversity net gain.
- Natural barriers (e.g. planting) and appropriate side slopes should be introduced to help manage perceived safety risks.
- On schemes that propose 10 or more dwellings, circa 40% of the site should be retained as green infrastructure, 10% of which may be required for SuDS detention or attenuation features dependent on drainage character.
- The location of SuDS features will naturally be determined by topography (working towards the lower end of the site) and must be outside of the key flood risk areas.
- Proposals must adopt the use of permeable paving in hard landscaped areas.

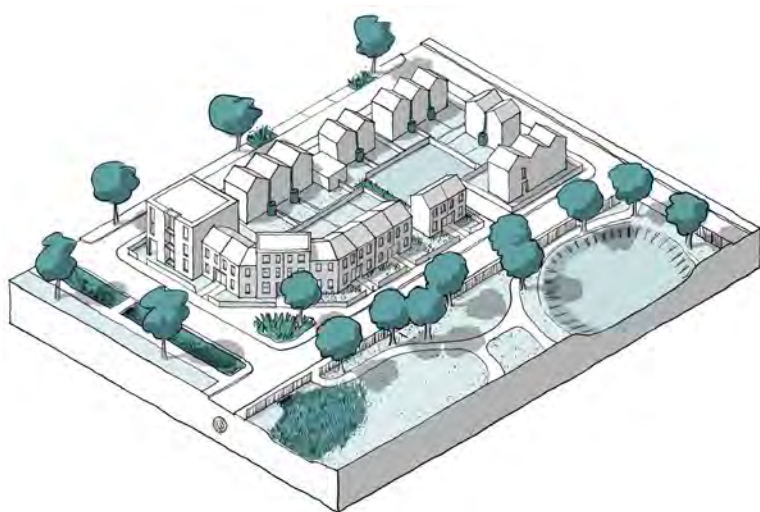

Figure 80: SuDS can be integrated into the wider landscape scheme as attractive soft landscape assets

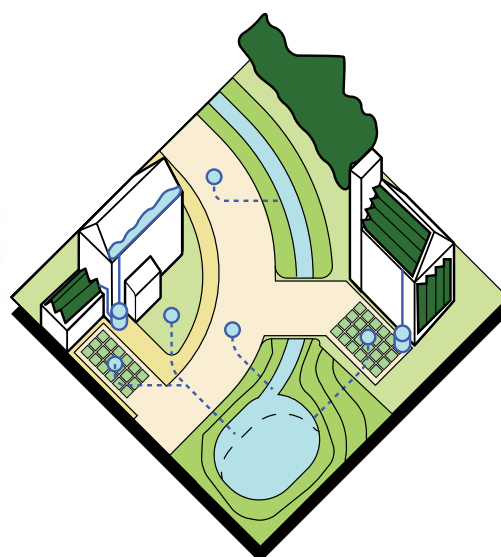

Figure 81: Flood mitigation can be in the form of swales, raingardens, and attenuation ponds. A combination of these are preferable.

About AECOM

AECOM is the world's trusted infrastructure consulting firm, delivering professional services throughout the project life cycle — from planning, design and engineering to program and construction management. On projects spanning transportation, buildings, water, new energy and the environment, our public- and private-sector clients trust us to solve their most complex challenges. Our teams are driven by a common purpose to deliver a better world through our unrivalled technical expertise and innovation, a culture of equity, diversity and inclusion, and a commitment to environmental, social and governance priorities. AECOM is a *Fortune 500* firm and its Professional Services business had revenue of \$13.2 billion in fiscal year 2020. See how we are delivering sustainable legacies for generations to come at aecom.com and [@AECOM](https://www.instagram.com/AECOM).